

SURGICAL INSTRUMENTS **CATALOGUE**



Diagnostics



Buck

MT-1-101-18



Buck

MT-1-102-18



Dejerine

MT-1-103-20



Dejerine

MT-1-104-21



Taylor Mod. USA

MT-1-105-20



Wartenberg

MT-1-106-19

Diagnostics



Pinard

MT-1-107-18



Pinard

MT-1-108-15

Anesthesia



Magill

MT-2-101-15



Miller

MT-1-101-18



Miller-Baby

MT-2-103-00



Miller

MT-2-104-00



Guedel-Negus

MT-2-105-00



Guedel-Negus

MT-2-106-00

Anesthesia



Guedel-Negus

MT-2-107-01



McIntosh

MT-2-108-00



McIntosh

MT-2-109-0



McIntosh

MT-2-110-00



Foregger

MT-2-111-01



Battery Handle

MT-2-112-00

Anesthesia



McIntosh

MT-2-114-00



McIntosh

MT-2-115-00



McIntosh

MT-2-116-00



McIntosh

MT-2-113-00

Trocars



Universal

MT-3-101-04



Nelson

MT-3-102-07



Lichtwitz

MT-3-103-19



Adson

MT-3-104-21



Frazier

MT-3-105-10



Frazier

MT-3-106-06

Trocars



Poppen

MT-3-107-06



Luer

MT-3-108-30



Yasargil

MT-3-109-15



Yankauer

MT-3-110-27



Yankauer

MT-3-111-00



Poole

MT-3-112-22

Trocars



Pooler

MT-3-113-22



Nuboer

MT-3-114-21



Nuboer

MT-3-115-21



Quinke

MT-3-116-10



Tuohy

MT-3-117-12



Verres

MT-3-118-20

Trocars



Verres

MT-3-119-20

Suture



Kalt

MT-4-105-14



Barraquer-Troutman

MT-4-106-10



Arruga

MT-4-107-14



Barraquer-Troutman

MT-4-108-10



Barraquer

MT-4-109-11



Barraquer

MT-4-110-13

Suture



Castroviejo-Fino

MT-4-111-01



Castroviejo-Fino

MT-4-112-01



Castroviejo-Fino

MT-4-113-01



Castroviejo

MT-4-114-14



Castroviejo

MT-4-115-14



Castroviejo

MT-4-121-14

Suture



Castroviejo

MT-4-122-14



Castroviejo

MT-4-124-13



Arruga

MT-4-123-16



Castroviejo

MT-4-125-12



Derf

MT-4-126-12

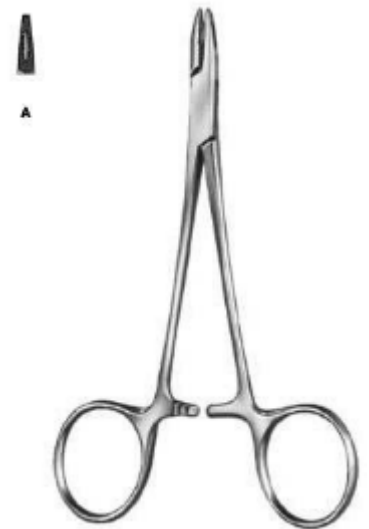

Collier

MT-4-127-12

Suture



Webster

MT-4-128-13



Halsey

MT-4-129-13



Neivert

MT-4-130-13



Metzenbaum

MT-4-141-18



M. G. Hospital

MT-4-142-17



Mayo-Hegar

MT-4-143-14

Suture



Adson

MT-4-140-18



Metzenbaum

MT-4-141-18



M. G. Hospital

MT-4-142-17



Mayo-Hegar

MT-4-143-14



Brown

MT-4-145-13



Mayo Hegar

MT-4-144-16

Suture

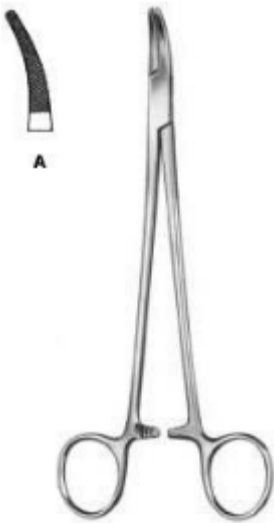

Heaney

MT-4-146-21

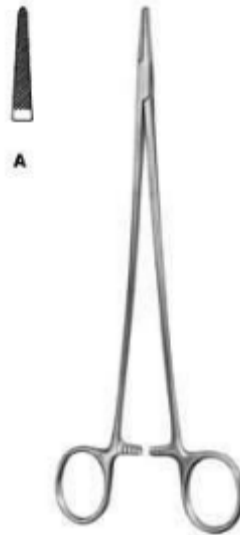

Jamison

MT-4-147-23



Masson

MT-4-148-27



Finochietto

MT-4-149-27



Wangensteen

MT-4-150-27

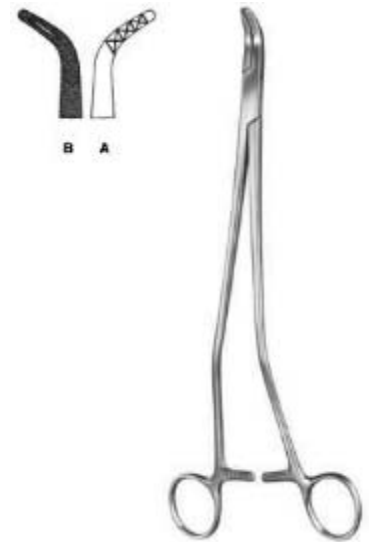

Johnson

MT-4-151-27

Suture

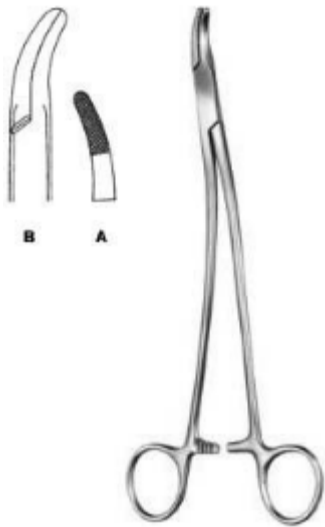

Stratte

MT-4-152-23

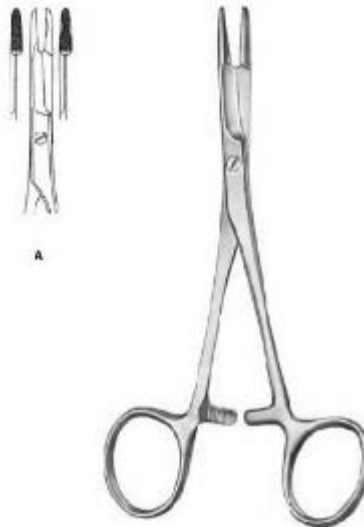

Olsen-Hegar

MT-4-153-14

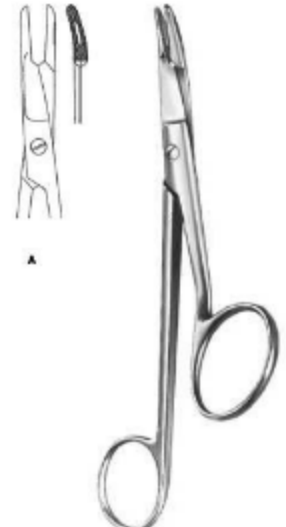

Gillies

MT-4-154-16



Crile

MT--155-15



Mathieu

MT-4-156-14



Mathieu

MT-4-157-14

Suture



Toennis

MT-4-158-18



Lichtenberg

MT-4-159-20



Micro Needle Holder

MT-4-160-16



Micro Needle Holder

MT-4-161



Hepp-Scheidel

MT-4-162-18

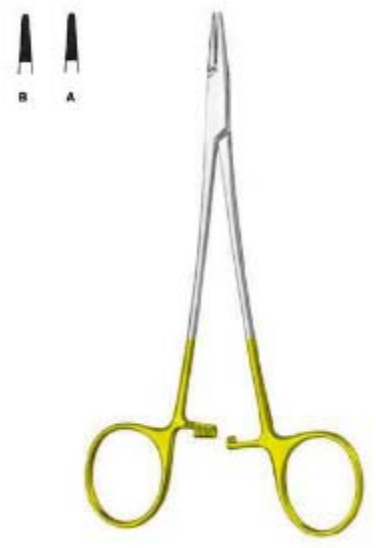

Webster

MT-4-163-13

Suture



Micro Needle Holder

MT-4-164-15



JABOMA

MT-4-165-18



Castroviejo

MT-4-166



Arruga

MT-4-167



Castroviejo

MT-4-168-13



Barraquer

MT-4-169-13

Suture



Barraquer
MT-4-170-13



Webster
MT-4-171-13



Derf
MT-4-173-12

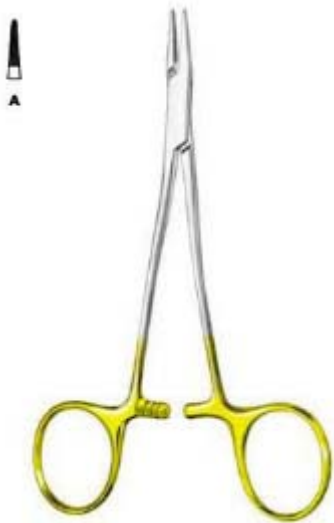

Kilner
MT-4-172-13



Hegar-Baumgartner
MT-4-174-13



Halsey
MT-4-175-12

Suture



Crile-Wood

MT-4-176-15



Sarot

MT-4-177-18

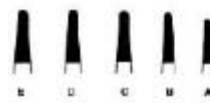

Mayo-Hegar

MT-4-178-16



Heaney

MT-4-179-20



DeBakey

MT-4-180-18



Masson

MT-4-181-27

Suture



Ryder (Martin)

MT-4-182-13



Martin

MT-4-183-15



Wangensteen

MT-4-184-27



Hegar-Vascular

MT-4-185-14

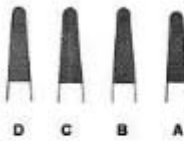

Bozemann

MT-4-186-20



Hegar

MT-4-187-20

Suture



Stratte

MT-4-188-22



Microvascular

MT-4-189-00



Mathieu

MT-4-190-14



Mathieu

MT-4-191-14



Mathieu

MT-4-192-17



Toennis

MT-4-193-18

Suture



Lichtenberg

MT-4-194-20



Langenbeck

MT-4-195-18



Zweifel

MT-4-196-20



Reverdin

MT-4-197-15



Reverdin

MT-4-198-19



Reverdin

MT-4-199-23

Suture



Schmieden-Dick

MT-4-201-01



Schmieden

MT-4-202-21



Ligature Needle Malleable

MT-4-203-20

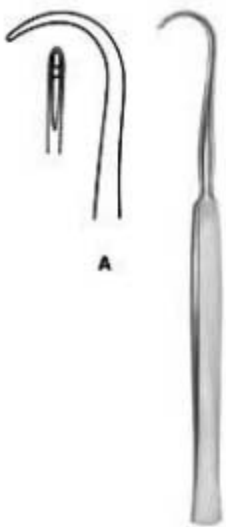

Cooper

MT-4-204-19



Kronecker

MT-4-205-13



Deschamps

MT-4-206-24

Suture



Deschamps

MT-4-207-20



Deschamps

MT-4-208-20

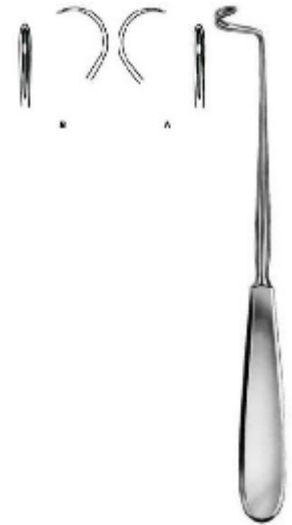

Deschamps

MT-4-209-21



Deschamps

MT-4-210-21

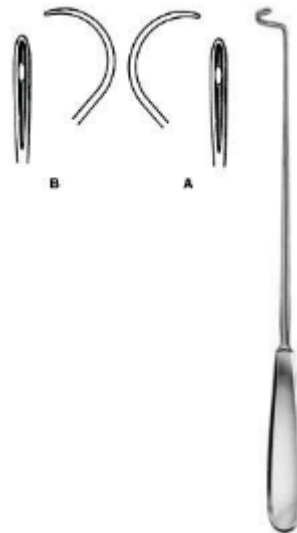

Deschamps

MT-4-211-27

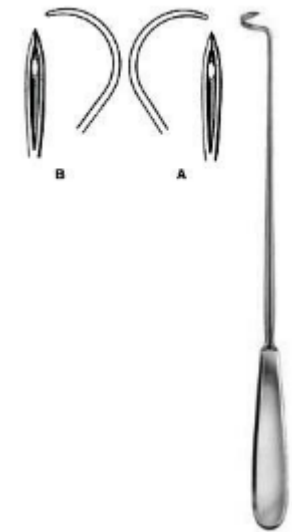

Deschamps

MT-4-212-27

Suture

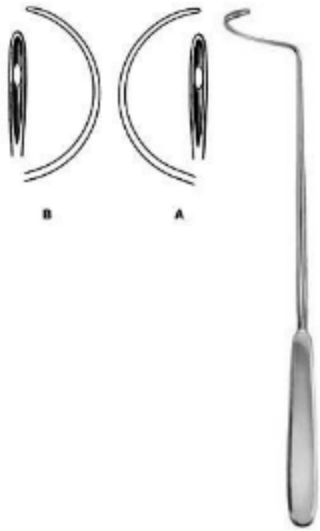

Deschamps

MT-4-213-28



Deschamps

MT-4-214-20



Deschamps

MT-4-215-20



Deschamps

MT-4-216-20

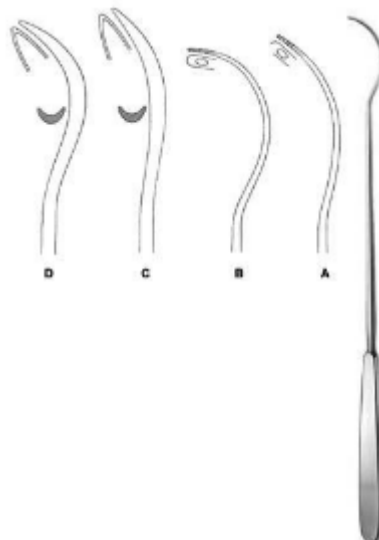

Brunner

MT-4-217-30



Kirschner

MT-4-218-25

Suture



Ligature Conductor

MT-4-219-28



Modell Wien

MT-4-220-23



Michel

MT-4-221-12



Hegenbarth

MT-4-222-12

Scalpels



Dissecting Knife

MT-5-101-01



Autopsy Knife

MT-5-102-10



Walb

MT-5-104-17



Virchow

MT-5-105-20



Scalpel Handle

MT-5-108-04



Scalpel Handle

MT-5-109-34

Scalples



Scalpel Handle

MT-5-110-41



Scalpel Handle

MT-5-111-45



Collin

MT-5-112-08



Collin

MT-5-113-09



Scalpel Handle

MT-5-114-03



Scalpel Handle

MT-5-115-04

Scalpels



Scalpel Handle

MT-5-116-05



Scalpel Handle

MT-5-117-31



Scalpel Handle

MT-5-118-35



Scalpel Handle

MT-5-119-07



Scalpel Handle

MT-5-120-71



Scalpel Handle

MT-5-121-03

Scalpels



Amputation Knife

MT-5-127-16



Amputation Knife

MT-5-128-19



Catlin

MT-5-129-16



Resection Knife

MT-5-130-06



Langenbeck

MT-5-131-05



Langenbeck

MT-5-132-05

Scalpels



Razor Knife

MT-5-133-00



Schink

MT-5-134-00



Schink

MT-5-135-01



Schink

MT-5-136-02

Scissors



Standard BL / BL Straight

MT-5-201-13



Standard SH / BL STR

MT-5-202-13



Standard SH / SH STR

MT-5-204-13



Standard BL / BL Curved

MT-5-205-13



Standard SH / BL Curved

MT-5-206-13



Standard SH / SH Curved

MT-5-207-13

Scissors



Standard BL / BL Curved

MT-5-208-14



Incision Scissor

MT-5-209-14



Deaver

MT-5-210-14



Mayo

MT-5-211-15



Mayo

MT-5-212-23



Mayo-Harrington

MT-5-213-22

Scissors

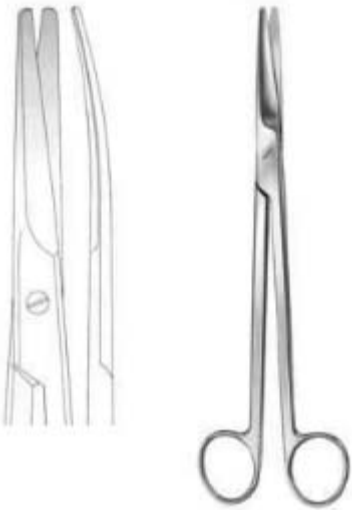

Mayo-Harrington

MT-5-214-22

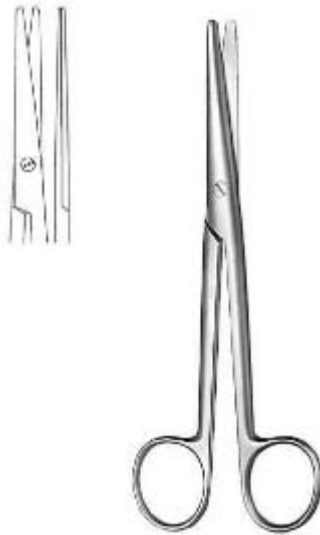

Mayo-Stille

MT-5-215-17

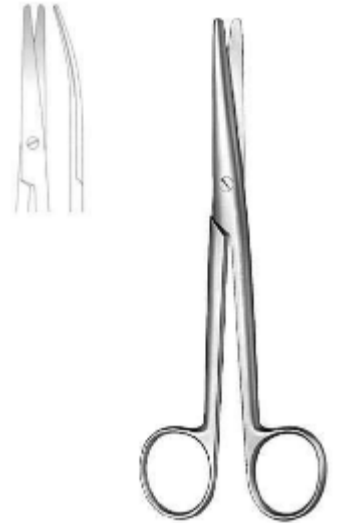

Mayo-Stille

MT-5-216-15

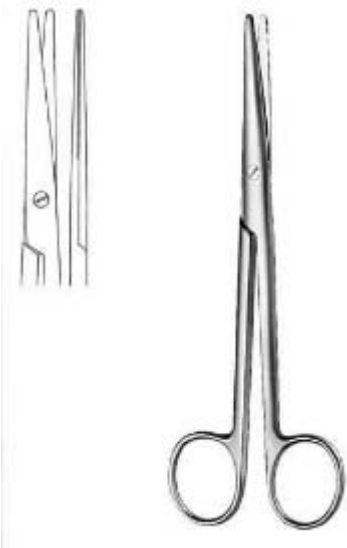

Mayo-Stille

MT-5-217-19

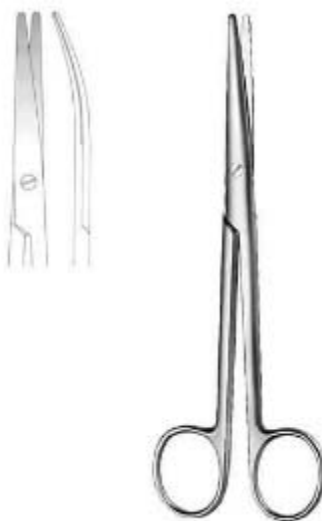

Mayo-Stille

MT-5-218-16



Mayo-Noble

MT-5-219-17

Scissors



Sims

MT-5-220-23



Sims

MT-5-221-20



Kelly

MT-5-222-16



Doyen

MT-5-223-17



Sims-Siebold

MT-5-224-24



Sims-Siebold

MT-5-225-24

Scissors



Wertheim

MT-5-226-23



Metzenbaum

MT-5-227-11



Metzenbaum

MT-5-228-14



Metzenbaum

MT-5-229-15



Metzenbaum-Nelson

MT-5-230-20



Metzenbaum-Nelson

MT-5-231-20

Scissors



Metzenbaum-Nelson

MT-5-232-20



Metzenbaum

MT-5-233-14



Nerve Operating Scissor

MT-5-234-15



Gorney

MT-5-235-19



Gorney

MT-5-236-19



Aston

MT-5-237-17

Scissors



Lexer

MT-5-238-16



Cinelli

MT-5-239-14



Thorek

MT-5-240-19



Lexer-Baby

MT-5-241-10



Lexer-Fino

MT-5-242-16



Metzenbaum-Fino

MT-5-243-14

Scissors



Metzenbaum-Fino

MT-5-244-14



Metzenbaum-Fino

MT-5-245-14



Metzenbaum-Fino

MT-5-246-14

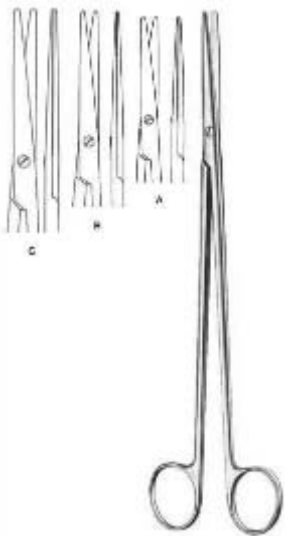

Metzenbaum-Fino

MT-5-247-18

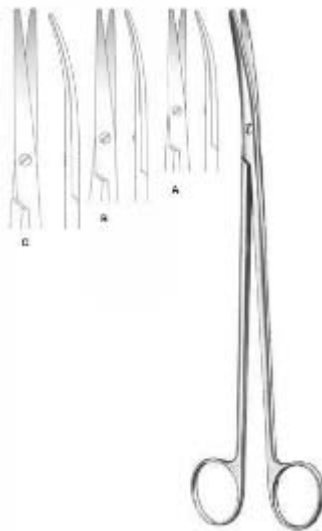

Metzenbaum-Fino

MT-5-248-18

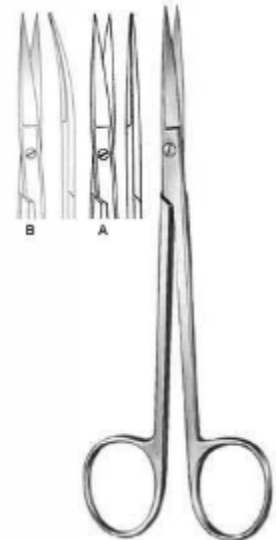

Sanvenero

MT-5-250-14

Scissors

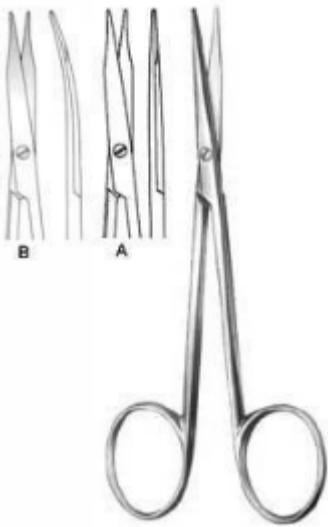

Fine Operating Scissors

MT-5-251-11

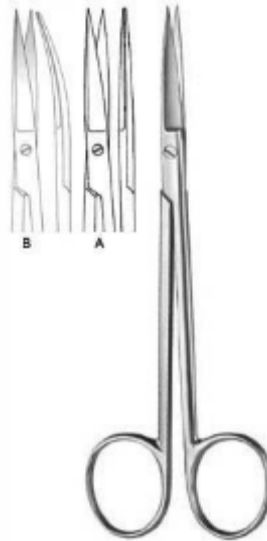

Joseph

MT-5-252-14

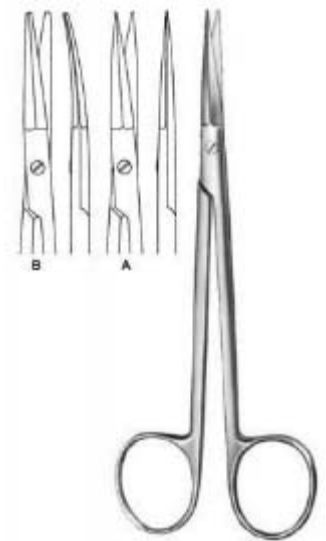

Peck-Joseph

MT-5-253-14

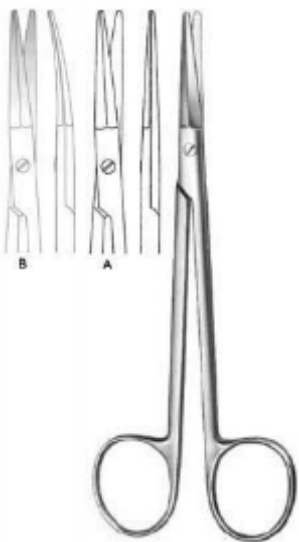

Peck-Joseph

MT-5-254-14



Shea Vein Graft

MT-5-255-12

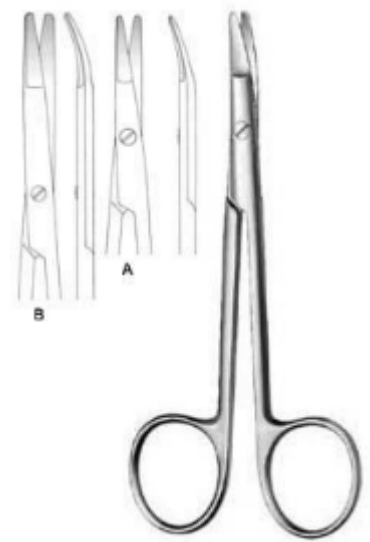

Kilner

MT-5-256-12

Scissors

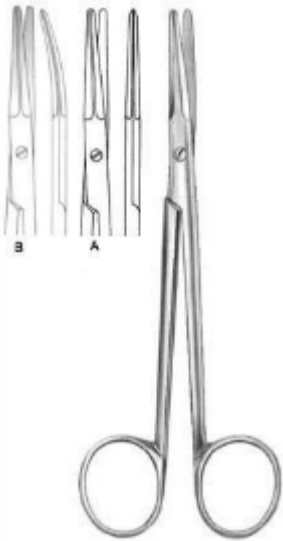

Dissecting Scissors

MT-5-257-14

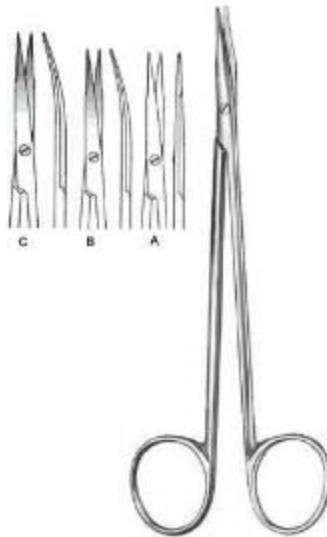

Reynolds

MT-5-258-15



Jameson

MT-5-259-14



Jameson

MT-5-260-14



Vascular Scissors

MT-5-261-19



Vascular Scissors

MT-5-262-24

Scissors

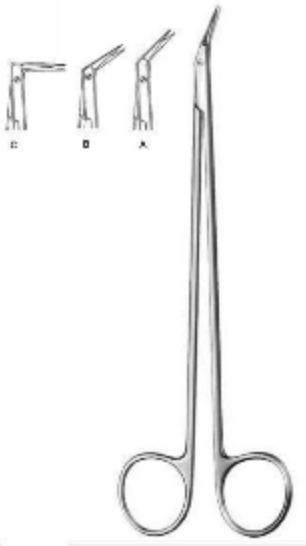

Diethrich

MT-5-263-25

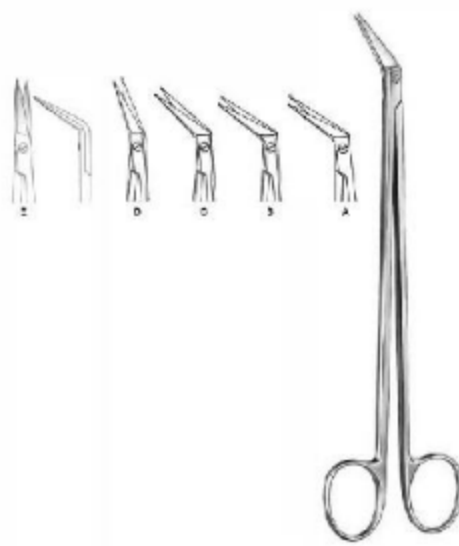

DeBakey

MT-5-264-45



Potts-Smith

MT-5-265-19



Coronary Scissors

MT-5-267-45



Coronary Scissors

MT-5-267-45



Coronary Scissors

MT-5-268-60

Scissors



Coronary Scissors

MT-5-269-90



Coronary Scissors

MT-5-270-00



Coronary Scissors

MT-5-271-00



Coronary Scissors

MT-5-272-25



Coronary Scissors

MT-5-273-45



Coronary Scissors

MT-5-274-90

Scissors



Schmieden-Taylor

MT-5-275-17



Strully

MT-5-276-22



Toennis-Adson

MT-5-277-17



Good

MT-5-279-19



Fomon

MT-5-282-15



Cottle

MT-5-283-16

Scissors



Heymann

MT-5-284-18



Heymann

MT-5-285-18



Converse

MT-5-286-11



Waldmann

MT-5-287-18



Braun-Stadler

MT-5-268-60



Braun-Stadler

MT-5-289-22

Scissors



Modell USA

MT-5-290-10



Busch

MT-5-292-16



Goldmann-Fox

MT-5-293-13



Wagner

MT-5-294-12

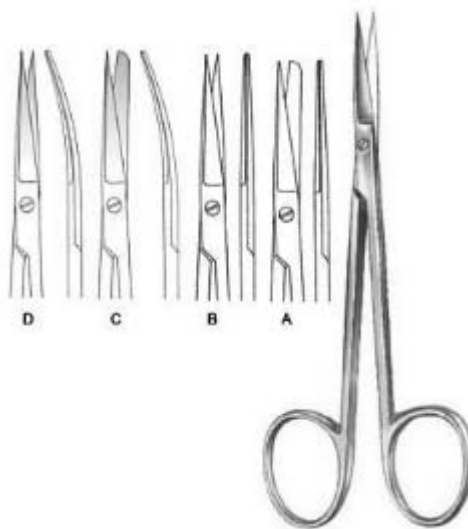

Operating Scissors

MT-5-295-12



La Grange

MT-5-296-11

Scissors



Dissecting Scissors

MT-5-297-11



Locklin

MT-5-298-16



Locklin

MT-5-299-16



Operating Scissors

MT-5-300-08

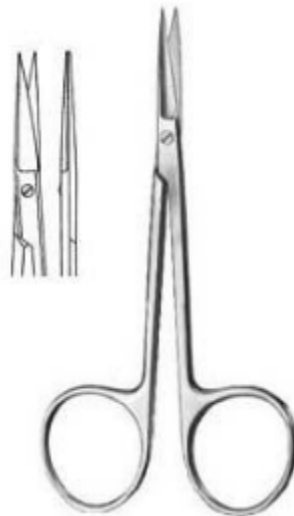

Iris Scissors

MT-5-301-10

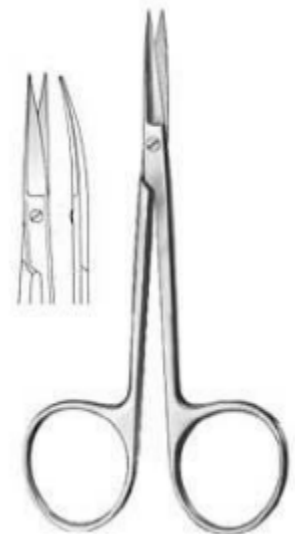

Iris Scissors

MT-5-302-10

Scissors



Iris Scissors

MT-5-303-10



Bonn

MT-5-304-09



Dean

MT-5-278-17



Spencer Scissor

MT-0-

Dressing & Tissue Forceps



Standard

MT-5-401-10



Standard

MT-5-402-11



Dressing Forceps

MT-5-403-13



Stille

MT-5-404-15



Mini-Adson

MT-5-405-12



Adson

MT-5-406-12

Dressing & Tissue Forceps



McIndoe

MT-5-405-12



Waugh

MT-5-408-20



Semken

MT-5-409-12



Taylor

MT-5-410-17



Taylor

MT-5-411-17



Taylor

MT-5-412-17

Dressing & Tissue Forceps



Dressing Forceps

MT-5-413-06



Gerald

MT-5-414-18



Cushing

MT-5-415-17



Potts-Smith

MT-5-416-18



Bonney

MT-5-417-17



Gerald

MT-5-418-17

Dressing & Tissue Forceps



Gillies

MT-5-419-15



McIndoe

MT-5-420-15



Semken

MT-5-421-16



Adson-Brown

MT-5-422-12



Adson

MT-5-423-12



Adson

MT-5-424-12

Dressing & Tissue Forceps



Cushing

MT-5-425-17



Cushing

MT-5-426-18



Cushing-Taylor

MT-5-427-18



Potts-Smith

MT-5-428-15



Oehler

MT-5-429-14



Wangensteen

MT-5-430-15

Dressing & Tissue Forceps



DeBakey

MT-5-421-16



DeBakey

MT-5-432-16



Dissecting Forceps

MT-5-433-10

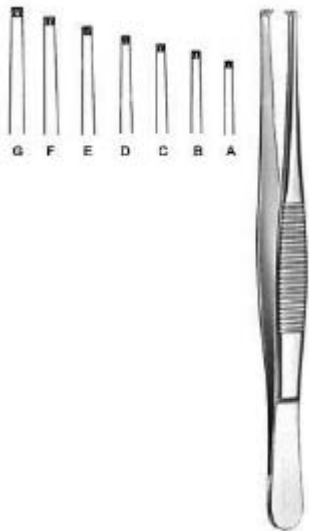

Dissecting Forceps

MT-5-434-11



Dissecting Forceps

MT-5-435-14



Dissecting Forceps

MT-5-436-14

Dressing & Tissue Forceps



Dissecting Forceps

MT-5-437-13



Dissecting Forceps

MT-5-438-13



Stille

MT-5-439-15



Stille

MT-5-440-15



Stone

MT-5-441-15



Lerche

MT-5-442-15

Dressing & Tissue Forceps



Adlerkreutz

MT-5-443-15

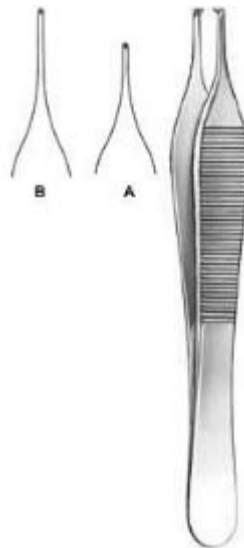

Adson

MT-5-444-12



Gillies

MT-5-445-15



Waugh

MT-5-446-20



Semken

MT-5-447-12



Taylor

MT-5-448-17

Dressing & Tissue Forceps



Taylor

MT-5-449-17



Taylor

MT-5-450-17



Dissecting Forceps

MT-5-451-06



Gerald

MT-5-452-17



Cushing

MT-5-453-17



Potts-Smith

MT-5-454-18

Dressing & Tissue Forceps

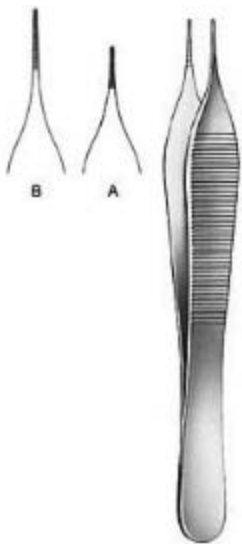

Mikro-Adson

MT-5-455-12

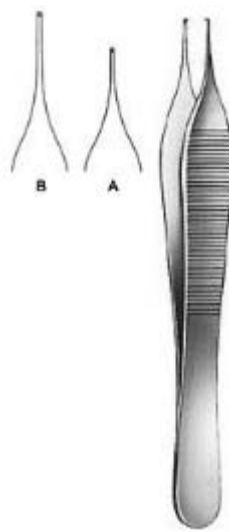

Mikro-Adson

MT-5-456-12



Dissecting Forceps

MT-5-457-11



Micro Jewelers

MT-5-458-12



Jewelers

MT-5-459-12



Jewelers

MT-5-460-11

Dressing & Tissue Forceps



Jewelers

MT-5-461-11



Jewelers

MT-5-462-11



Stille-Barraya

MT-5-463-18



Bonney

MT-5-464-18



Nelson

MT-5-465-23



Dressing Forceps

MT-5-466-10

Dressing & Tissue Forceps



Splinter Forceps Smooth Jaw

MT-5-467-12



Splinter Forceps Smooth Jaw

MT-5-468-12



Splinter Forceps

MT-5-469-12



Splinter Forceps

MT-5-470-12



Micro Tying Forceps

MT-5-471-16



**Microscopic Forceps Super
Light, Blunt**

MT-5-472-10

Dressing & Tissue Forceps



Microscopic Forceps

MT-5-473-10



Shaaf

MT-5-474-09



Littauer

MT-5-475-08



Cilia Forceps

MT-5-476-09



Douglas

MT-5-477-09



Douglas

MT-5-478-09

Dressing & Tissue Forceps



Beer

MT-5-479-09

Splinter Forceps



Phaneuf

MT-5-501-21



Wertheim-Cullen

MT-5-502-21

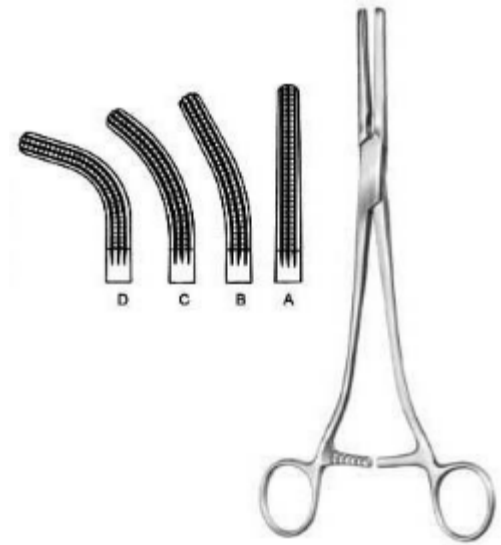

Rogers

MT-5-503-10



Moynihan

MT-5-504-23



Moynihan

MT-5-505-24



Wertheim

MT-5-506-25

Splinter Forceps

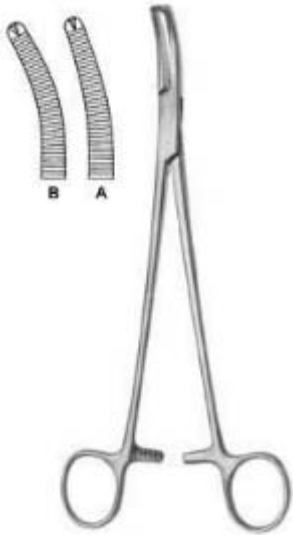

Wertheim

MT-5-507-22



Mikulicz, Baby

MT-5-508-14



Mikulicz

MT-5-509-18



Mikulicz

MT-5-510-20



Mikulicz

MT-5-511-20



Mikulicz

MT-5-512-21

Splinter Forceps



Faure

MT-5-513-20

Haemostatic Forceps

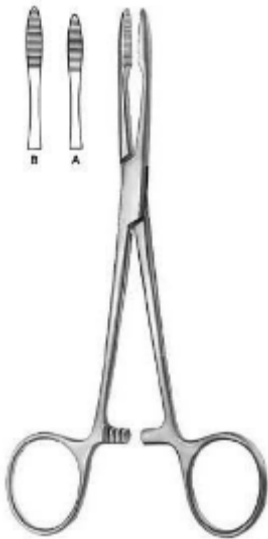

Pean

MT-5-601-14

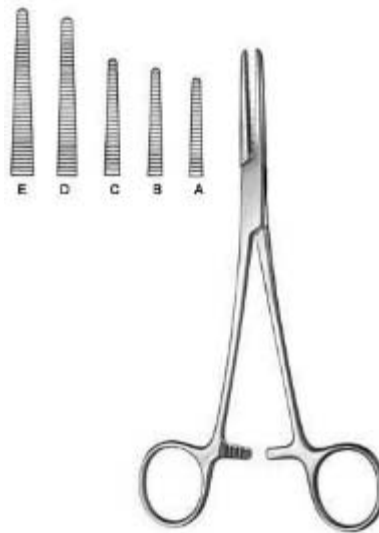

Spencer-Wells

MT-5-602-13

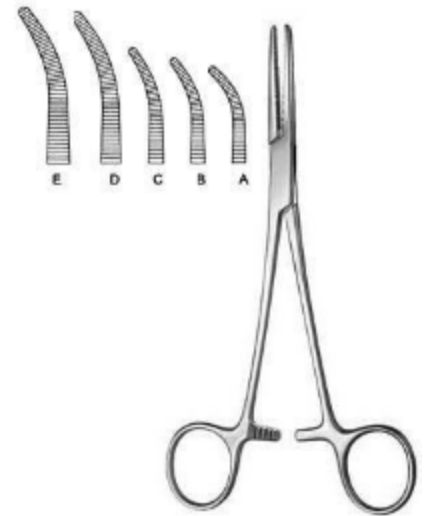

Spencer-Wells

MT-5-603-13



Chaput

MT-5-604-13



Tuffier

MT-5-605-13

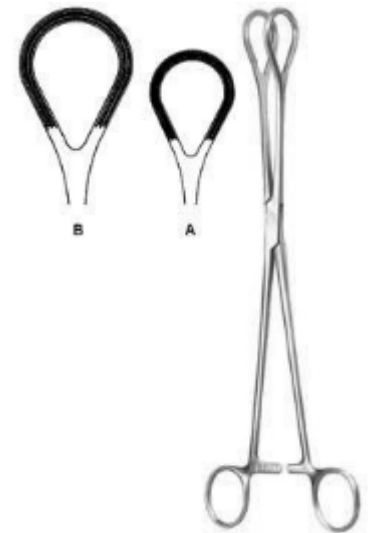

Grasping Forceps

MT-5-606-25

Haemostatic Forceps



Collin

MT-5-607-14



Collin

MT-5-608-17



Pennington

MT-5-609-15



Pratt

MT-5-610-15



Martel-Rees

MT-5-611-14



Ligature Forceps

MT-5-612-12

Haemostatic Forceps



Mixer-Baby

MT-5-613-01

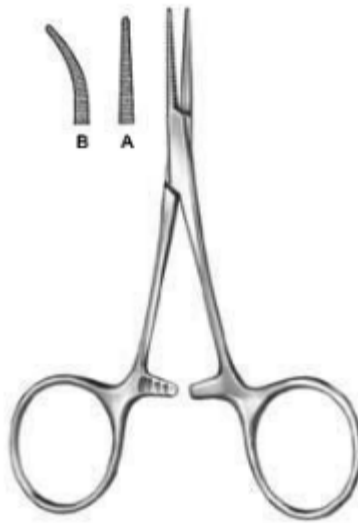

Hartmann

MT-5-614-10



Ligature Forceps

MT-5-615-12

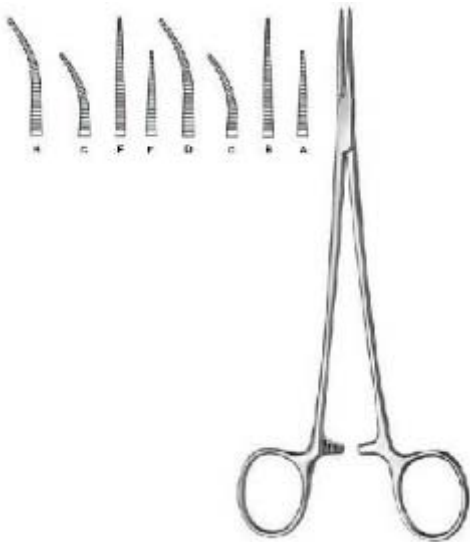

Halsted-Mosquito

MT-5-616-18



Mikro-Mosquito

MT-5-617-10



Providence-Hospital

MT-5-618-14

Haemostatic Forceps



Leriche

MT-5-619-15

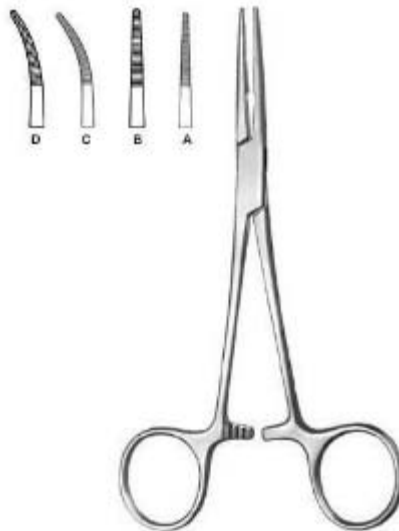

Kelly

MT-5-620-14

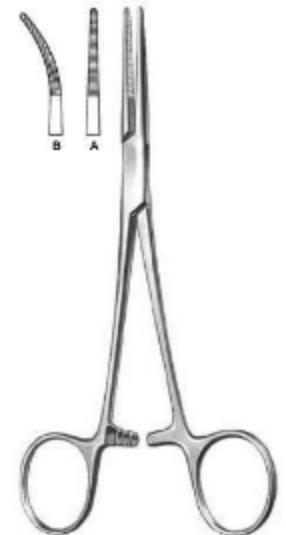

Kelly-Rankin

MT-5-621-16



Overholt-Baby

MT-5-622-14



Crile

MT-5-623-14



Crile-Rankin

MT-5-624-16

Haemostatic Forceps



Lovelace

MT-5-625-15



Dandy-Mosquito

MT-5-626-12

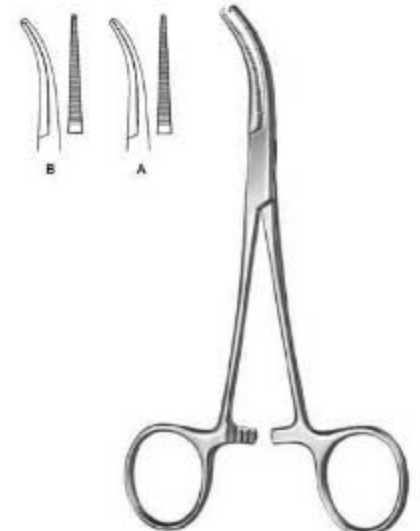

Dandy

MT-5-627-14



Schmidt

MT-5-628-18



Adson

MT-5-629-18



Martin-Fuchsig

MT-5-630-20

Haemostatic Forceps

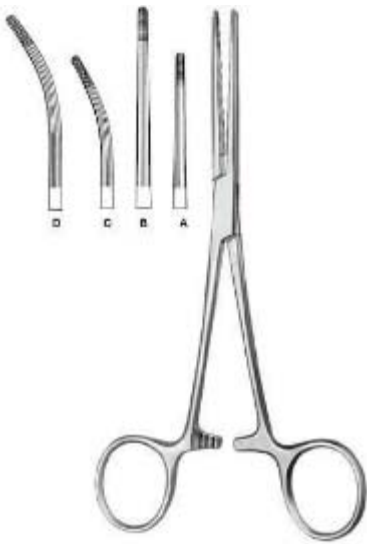

Rochester-Carmalt

MT-5-631-16

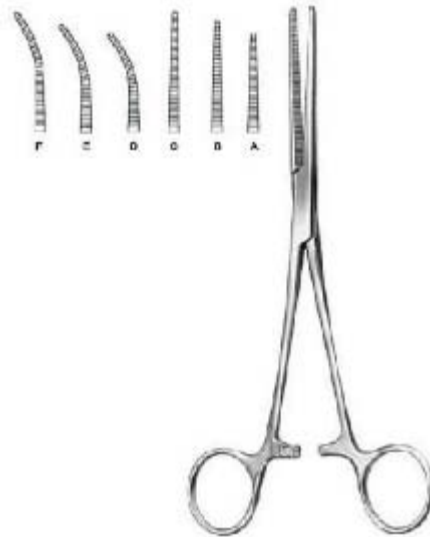

Pean

MT-5-632-13

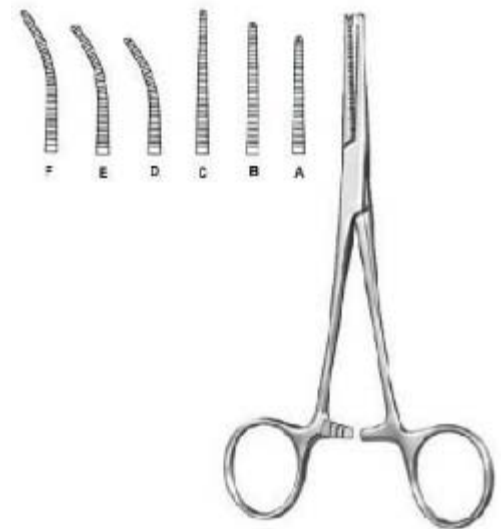

Kocher-Nippon

MT-5-633-14

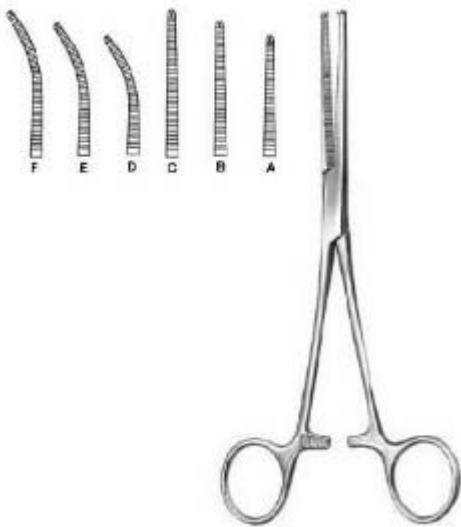

Kocher

MT-5-635-13

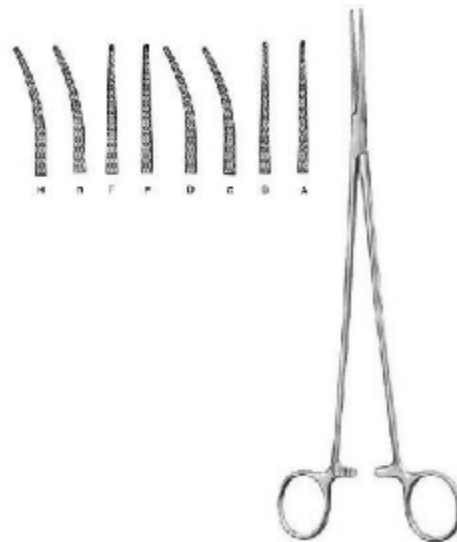

Bengolea

MT-5-636-20

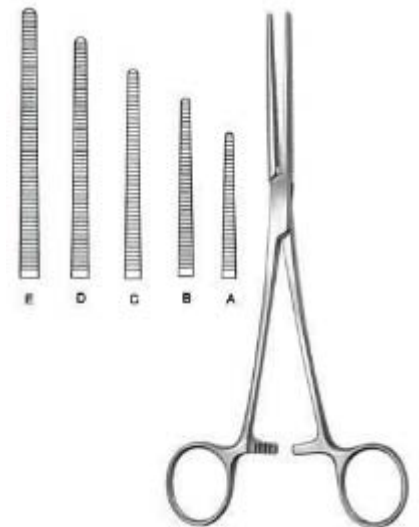

Pean (Rochester)

MT-5-637-14

Haemostatic Forceps

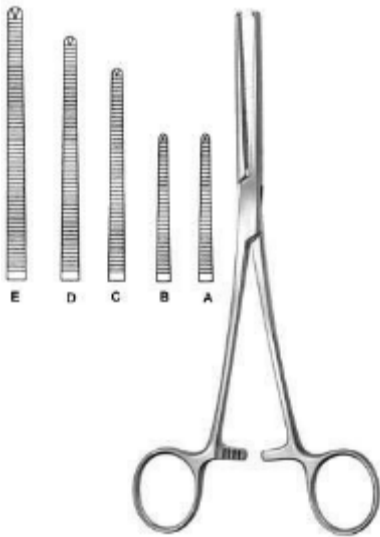

Kocher (Ochsner)

MT-5-638-14

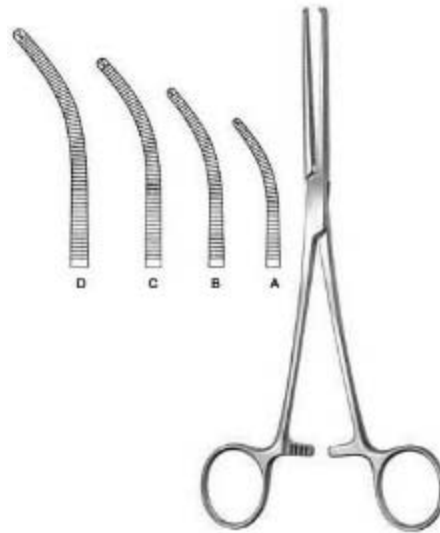

Kocher (Ochsner)

MT-5-639-14

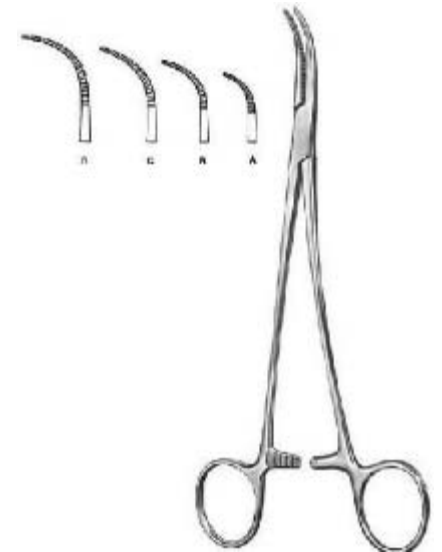

Overholt-Martin

MT-5-640-01



Mixer-Baby

MT-5-641-18



Adson-Baby

MT-5-640-01



Heiss

MT-5-643-01

Haemostatic Forceps



Overholt-Mixter

MT-5-644-21

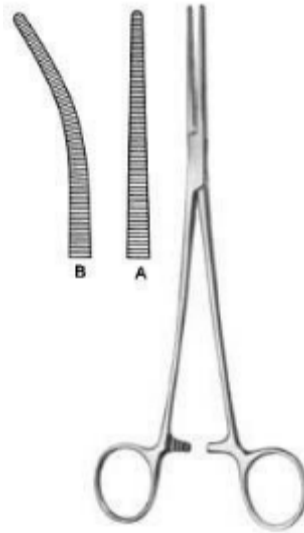

Roberts

MT-5-645-22

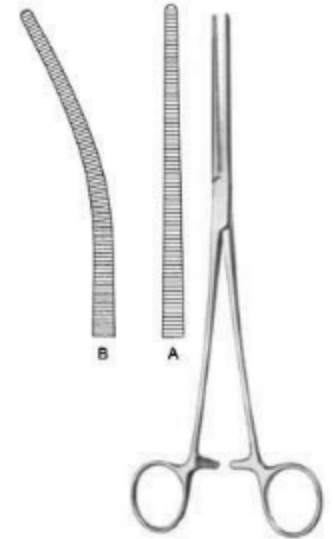

Sarot

MT-5-646-24



Craford

MT-647-18

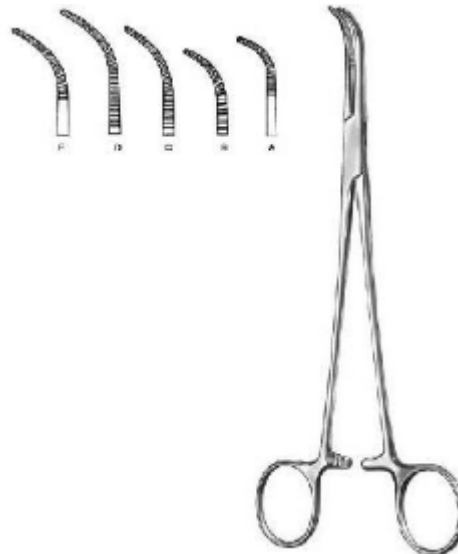

Overholt-Geissendorfer

MT-5-648-01

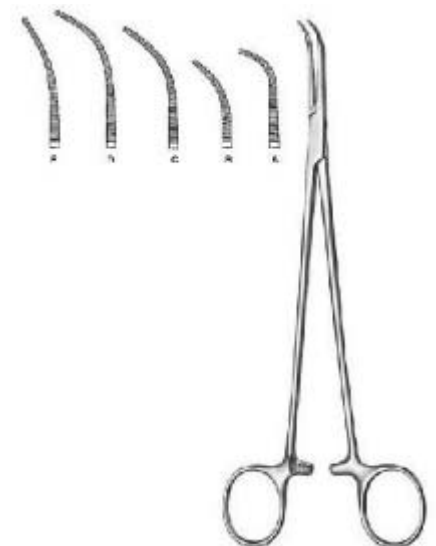

Overholt-Fino

MT-5-649-00

Haemostatic Forceps

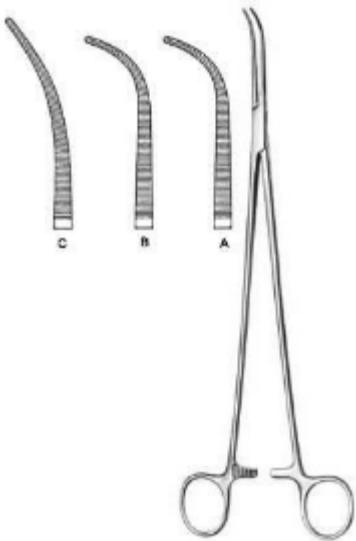

Overholt

MT-5-650-00



Overholt-Mini

MT-5-651-01



Gemini

MT-5-652-13

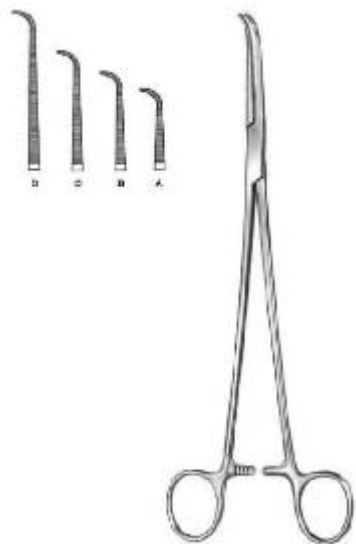

Mini-Gemini

MT-5-653-18

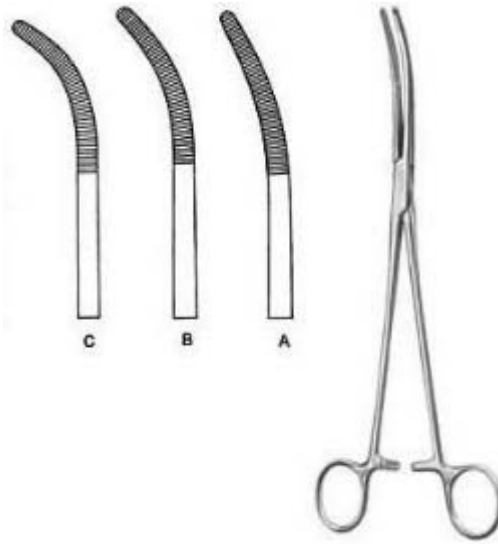

Rumel

MT-5-654-01

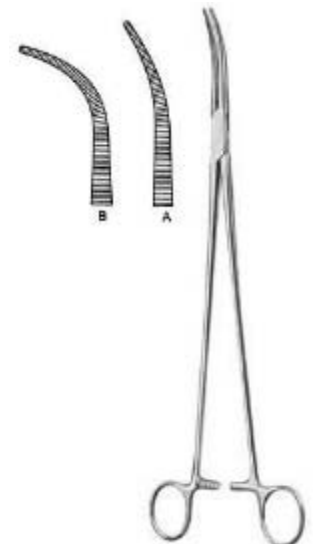

Zenker

MT-5-655-01

Haemostatic Forceps



Mixer-Baby

MT-5-656-14



Mixer

MT-5-657-15



Mixer-O Shaugnessy

MT-5-658-19



Mixer

MT-5-659-22



Mixer

MT-5-660-23



Wickstrom

MT-5-661-21

Haemostatic Forceps

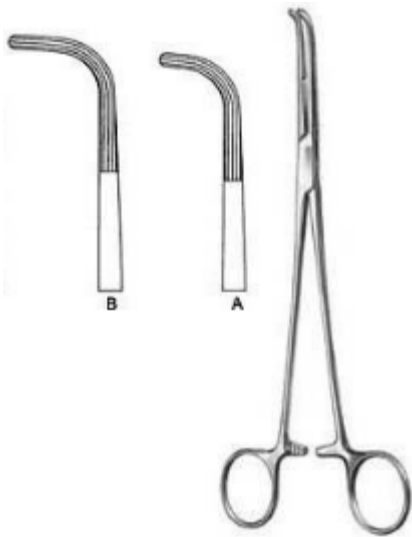

Mixer

MT-5-662-22



Mc Quigg-Mixer

MT-5-663-22



Lower

MT-5-664-18



Lahey

MT-5-665-19



Finochietto

MT-5-666-24



Uro-Tangential

MT-5-667-01

Haemostatic Forceps

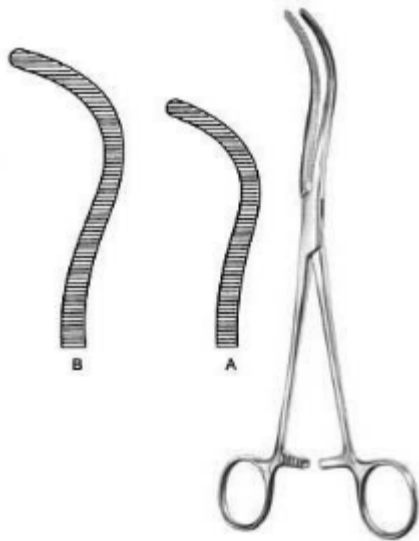

Guyon

MT-5-668-20



Guyon

MT-5-669-23



Desjardins

MT-5-670-21



Kelly

MT-5-671-19



Lawrence

MT-5-672-28



Meeker

MT-5-673-28

Haemostatic Forceps



Negus

MT-5-674-19

Towel & Tubing Clamps



Schaedel

MT-5-701-09



Jones

MT-5-702-05



Jones-Martin

MT-5-703-09



Backhaus

MT-5-705-11



Backhaus

MT-5-706-08



Peers-Bertram Modif.

MT-5-707-15

Towel & Tubing Clamps



R?der

MT-5-708-13

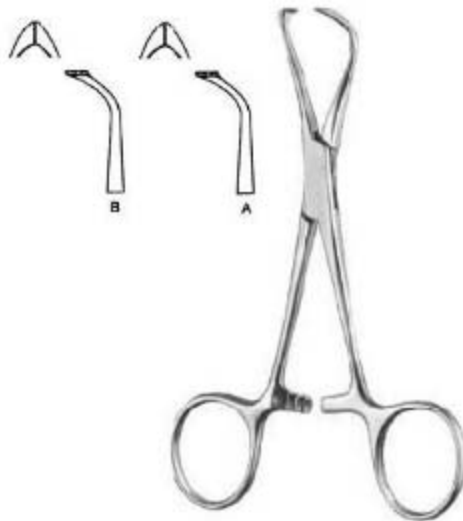

Lorna

MT-5-709-10



Bernhard

MT-5-710-16

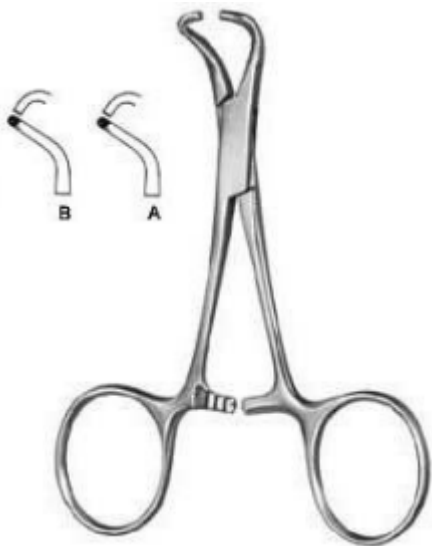

Tohoku

MT-5-711-10

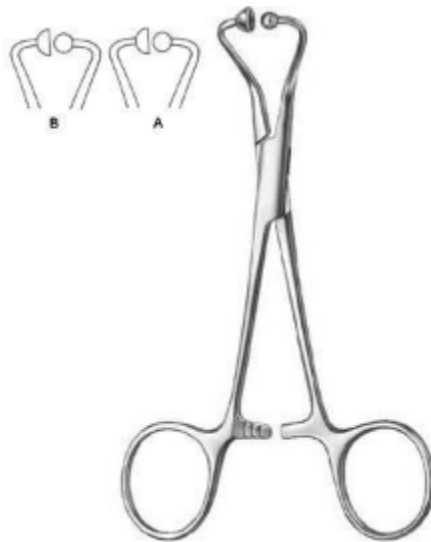

Towel Clamp For Paper Clothes

MT-5-712-11



Lane

MT-5-713-20

Towel & Tubing Clamps



Tube Holder For Fixation Of Six Tubes

MT-5-714-06



Tubing Clamp Extra Long Ratchet

MT-5-715-14



Tubing Clamp

MT-5-716-16

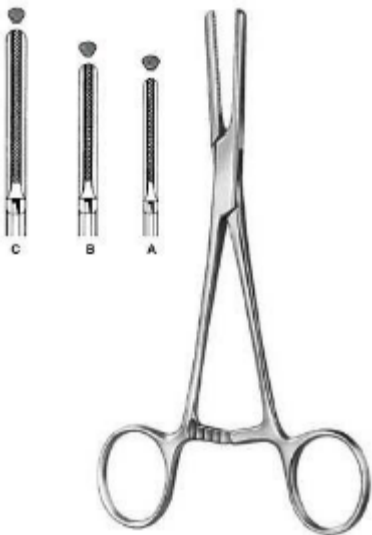

Tubing Clamp

MT-5-717-15

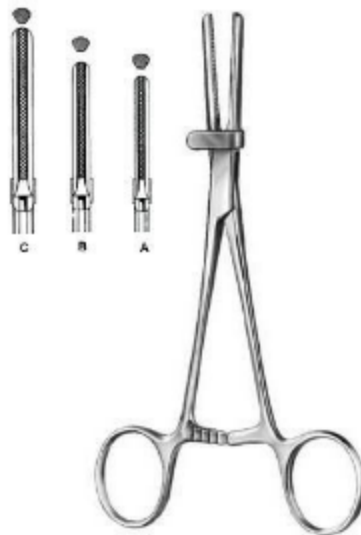

Tubing Clamp With Safety Guard

MT-5-718-15



Backhaus

MT-5-704-11

Dressing & Sponge Forceps

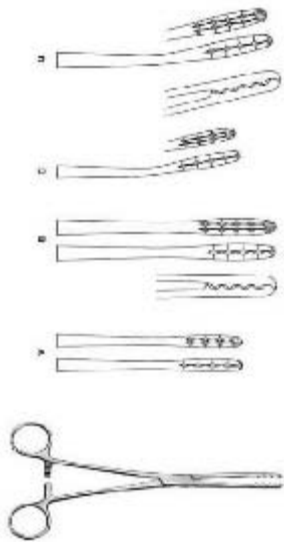

Ulrich

MT-5-801-22



Lister

MT-5-802-13



Martin

MT-5-803-17

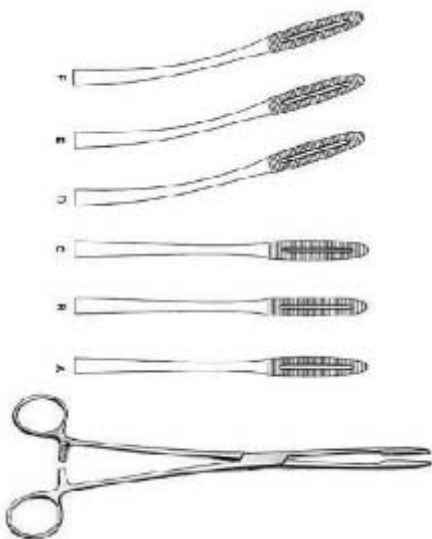

Gross-Maier

MT-5-804-20



Tunneling Forceps

MT-5-805-40



Collin

MT-5-806-25

Dressing & Sponge Forceps



Cheron

MT-5-807-25



Bozemann

MT-5-808-26

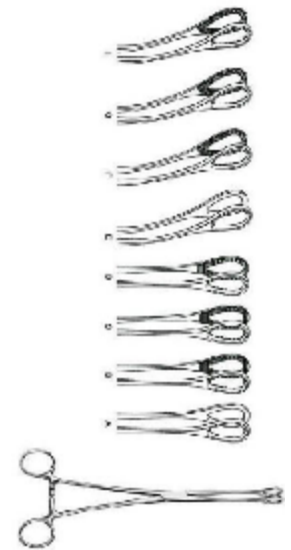

Foerster

MT-5-809-25

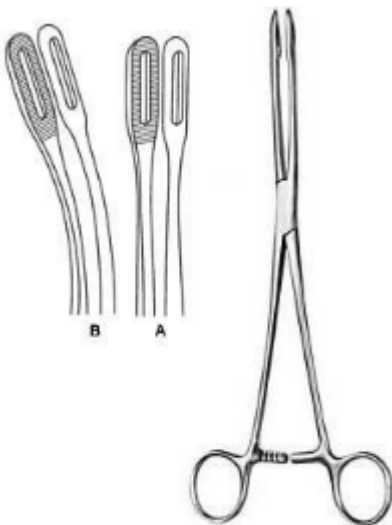

Foerster

MT-5-810-25

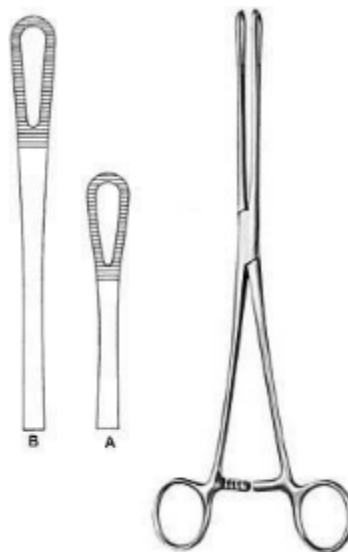

Rampley

MT-5-811-18

Retractors



Vickers

MT-5-901-18



Vickers

MT-5-902-01



Vickers

MT-5-903-01



Vickers

MT-5-904-02

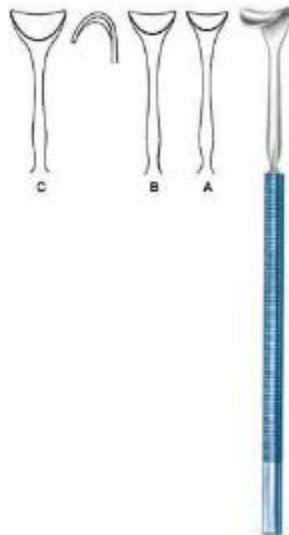

Vickers

MT-5-905-12



Graefe

MT-5-906-01

Retractors

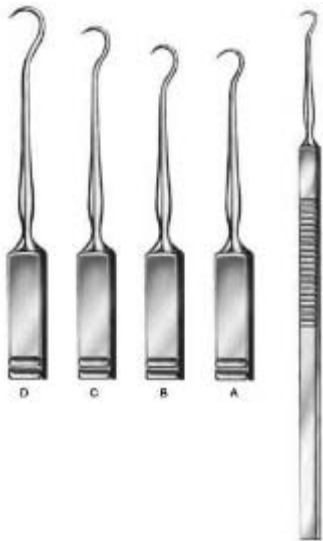

Skin Hook

MT-5-907-01



O Connor

MT-5-908-16



Guthrie

MT-5-909-01



Hooklet

MT-5-910-01



Hooklet

MT-5-911-01



Hooklet

MT-5-912-02

Retractors



Hooklet

MT-5-913-04



Vessel Hook

MT-5-914-12



Desmarres

MT-5-915-08

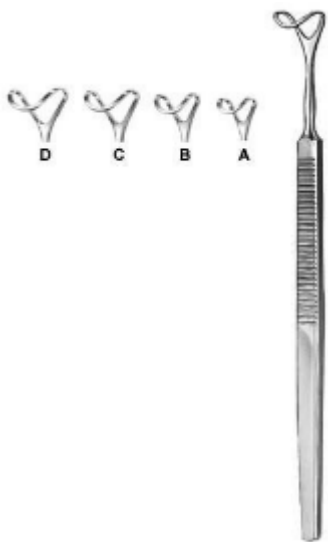

Saddle Hook

MT-5-916-12



Langenbeck-Mini

MT-5-917-10



Hooklet

MT-5-918-16

Retractors



Hooklet

MT-5-919-01



Hooklet

MT-5-920-01



Meyering

MT-5-921-01



Senn-Green

MT-5-922-01



Ragnell-Davis

MT-5-923-14

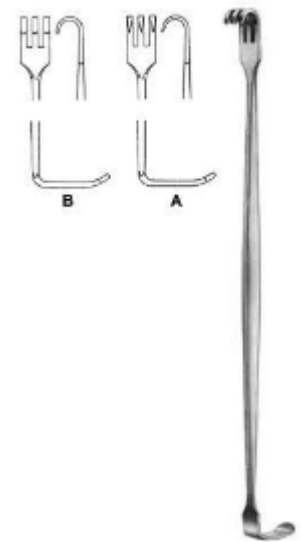

Senn-Miller

MT-5-924-16

Retractors



Cushing

MT-5-925-20



Cushing

MT-5-926-08



Cushing

MT-5-927-08



Brom

MT-5-928-01



Strandell-Stille

MT-5-929-01



Klapp

MT-5-930-01

Retractors



Hooklet

MT-5-931-04

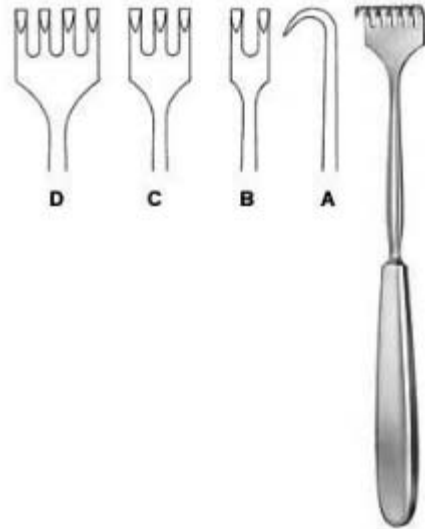

Volkmann

MT-5-932-01



Volkmann

MT-5-933-01



Kocher

MT-5-934-01

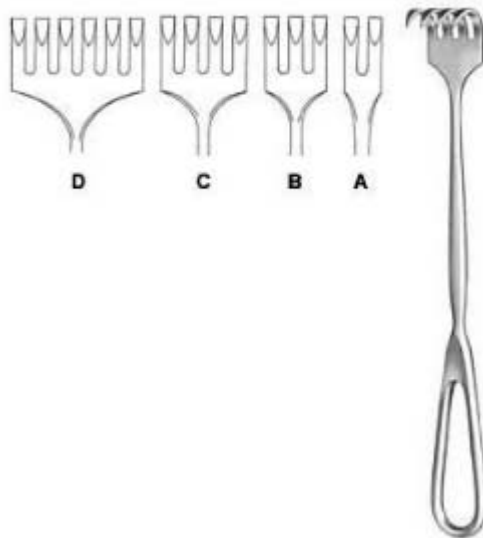

Martin

MT-5-935-02

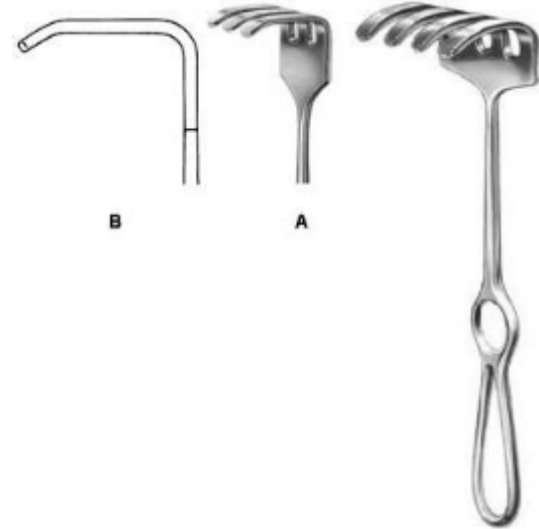

Ollier

MT-5-936-03

Retractors



Wassmund

MT-5-937-02

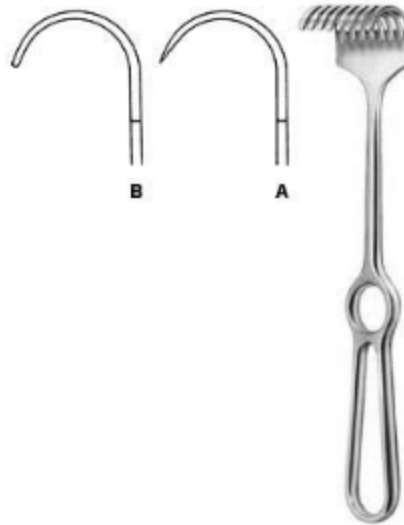

Korte

MT-5-938-08

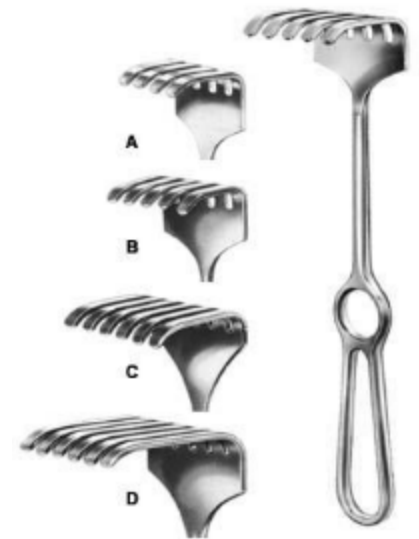

Israel

MT-5-939-04

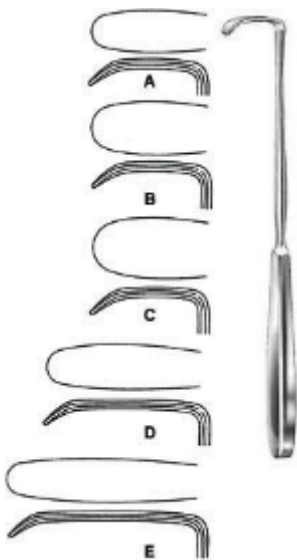

Langenbeck

MT-5-940-01



Langenbeck

MT-5-942-21



Langenbeck

MT-5-943-21

Retractors



Lahey

MT-5-944-19



Little

MT-5-945-20



Kocher

MT-5-946-18

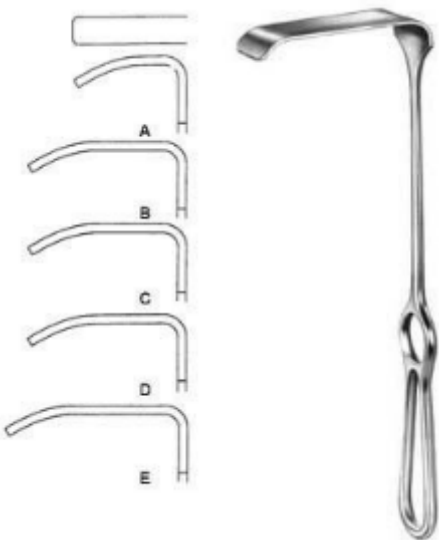

Kocher-Langenbeck

MT-5-947-01

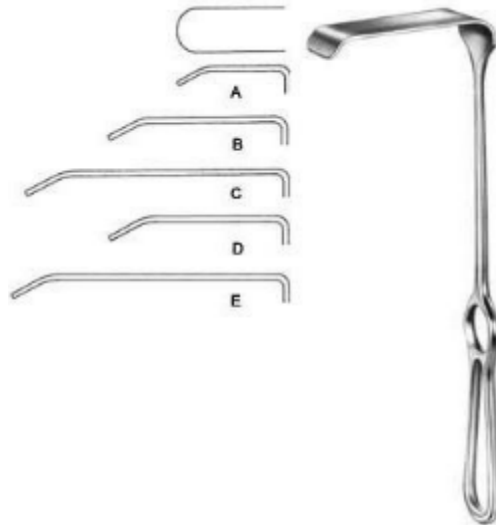

Kocher-Langenbeck

MT-5-948-01

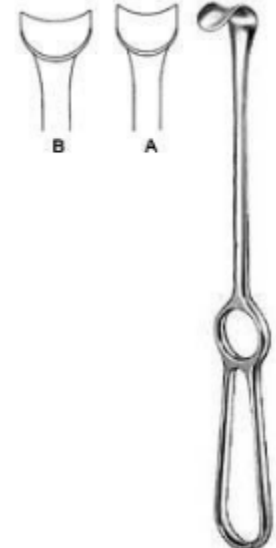

Kocher

MT-5-949-01

Retractors

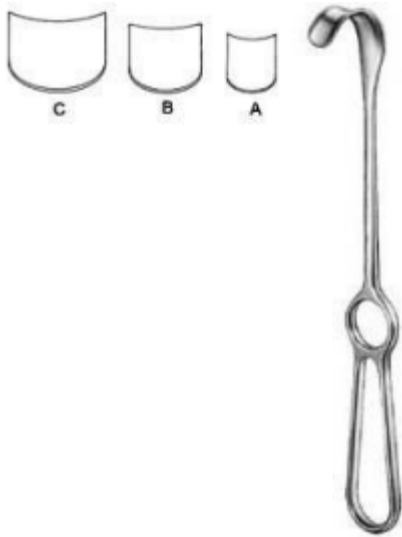

Kocher
MT-5-950-01

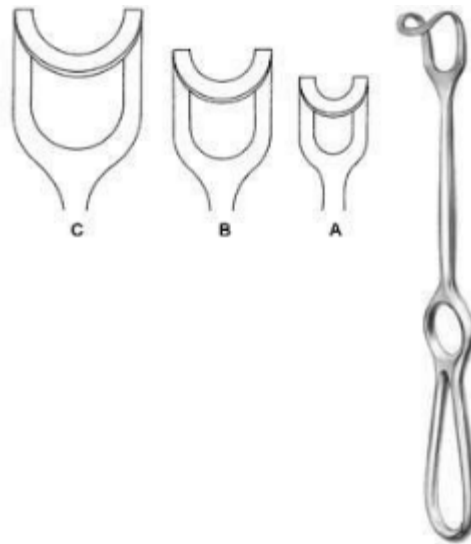

Middeldorpf
MT-5-951-01



Doyen-Stillé
MT-5-952-01



Hosel
MT-5-953-01



Middeldorpf
MT-5-954-01

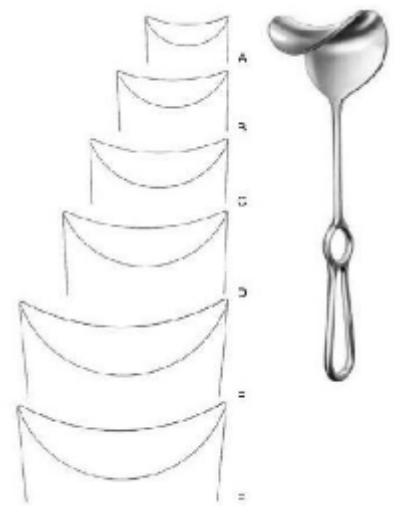

Fritsch
MT-5-955-00

Retractors



Doyen

MT-5-956-25



Kocher

MT-5-957-22



Kocher

MT-5-958-01



Martin

MT-5-959-25

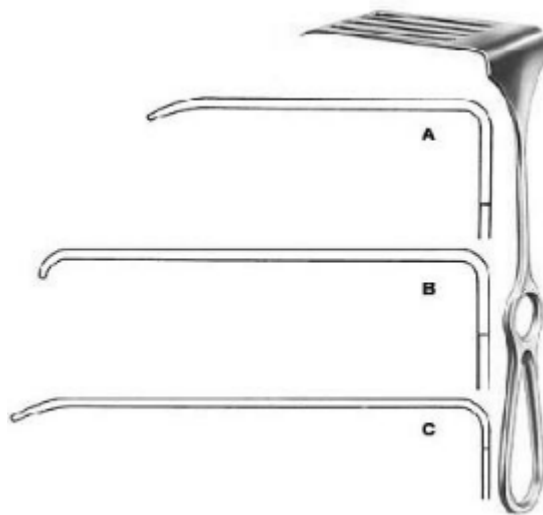

Coryllos

MT-5-960-01



Davidson

MT-5-961-01

Retractors



Sauerbruch

MT-5-962-25

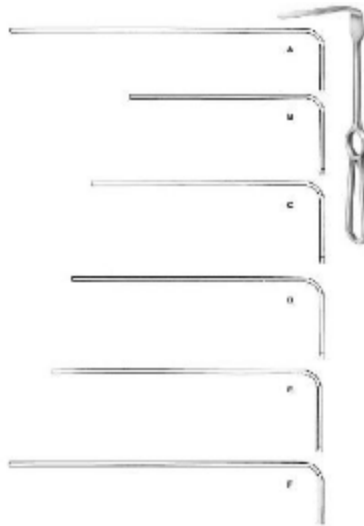

Brunner

MT-5-963-08

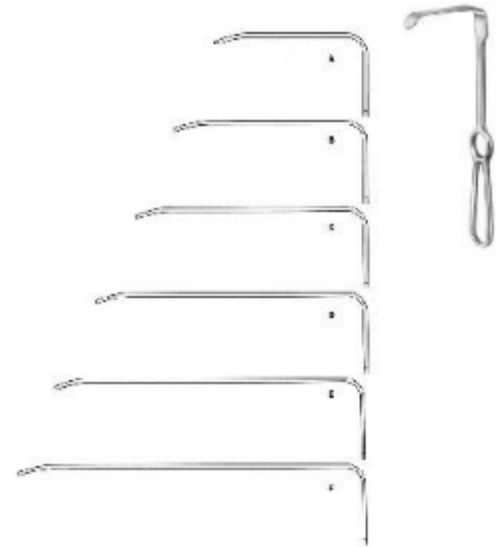

Brunner

MT-5-964-08

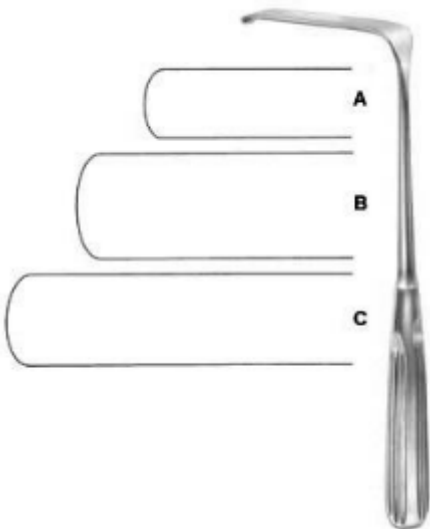

Sauerbruch

MT-5-965-01



Deaver

MT-5-966-01



Mikulicz

MT-5-968-01

Retractors



Mikulicz

MT-5-969-26

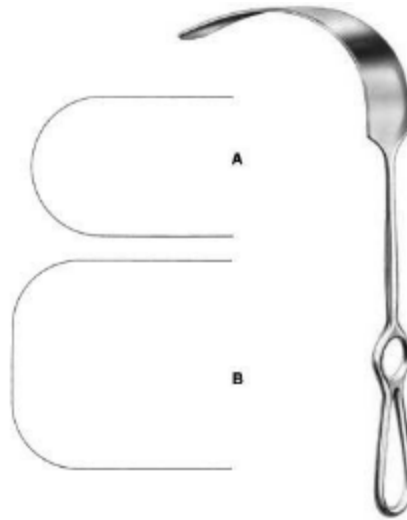

Kelly

MT-5-970-01



Farabeuf

MT-5-971-00

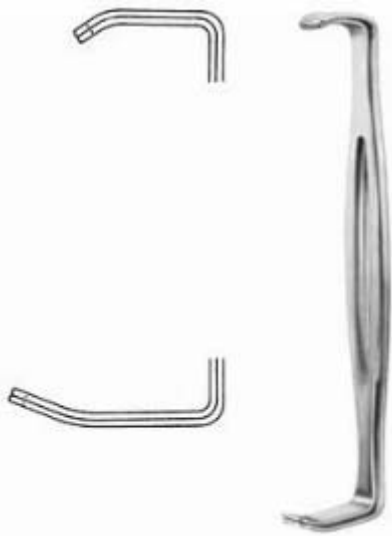

Parker-Langenbeck

MT-5-972-00



Alm

MT-5-973-07



Alm

MT-5-974-07

Retractors



Gosset

MT-5-975-22



Balfour-Baby

MT-5-976-00



Balfour

MT-5-977-00



Deaver

MT-5-967-04

Probes



Probe

MT-5-1001-11



Probe

MT-5-1002-11



Probe

MT-5-1003-13



Probe With Eye

MT-5-1004-13



Myrtle Leaf Probe

MT-5-1006-13



Grooved Director

MT-5-1007-13

Probes



Grooved Director

MT-5-1008-13



Doyen

MT-5-1009-14



Nelaton

MT-5-1010-16

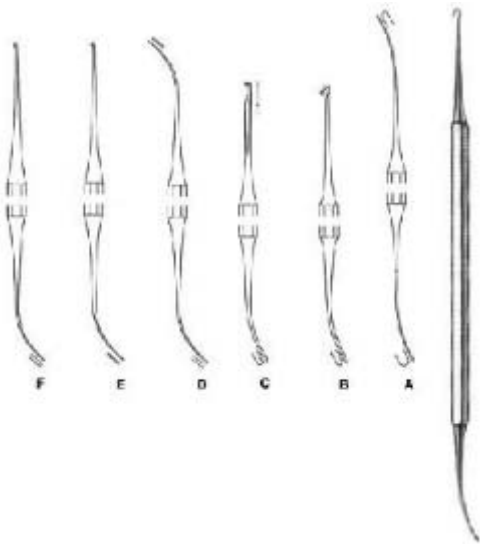

Varady

MT-5-1011-01

Plaster

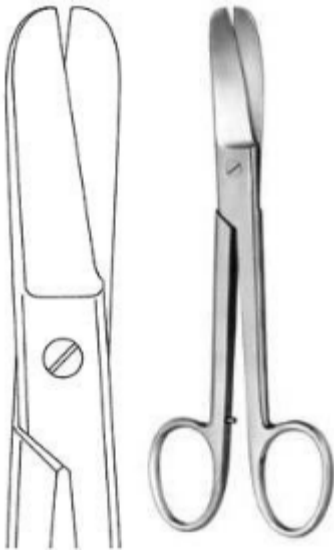

Lorenz

MT-6-101-23



Lister

MT-6-102-14



Bergmann

MT-6-103-23



Esmarch

MT-6-104-20



**Bandage Scissors Black Plastic
Ring With Autodavable**

MT-6-105-15



**Bandage Scissors Black Plastic
Rings**

MT-6-106-18

Plaster

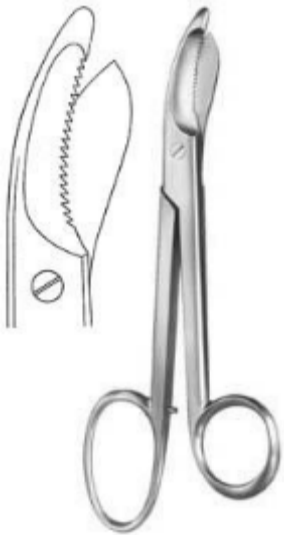

Bruns

MT-6-107-24



Stille-Martin

MT-6-108-23

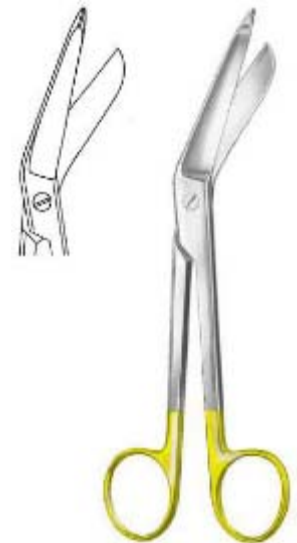

Lister

MT-6-109-18



Bruns

MT-6-110-24



Hopkins

MT-6-111-20



Reiner

MT-6-112-18

Plaster



Reiner

MT-6-113-18



Martin

MT-6-114-21



Engel

MT-6-115-14

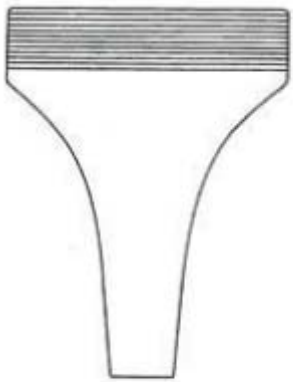

Hennig

MT-6-116-28



Wolff

MT-6-117-18

Neurosurgery



Gigli

MT-8-101-01



De Martel

MT-8-102-33



Crutchfield

MT-8-103-01



**Skull Traction Tong Large
Pattern**

MT-8-104-01



Dahlgren

MT-8-105-20



Olivecrona-Toennis

MT-8-106-14

Neurosurgery



McKenzie

MT-8-107-19



Olivecrona

MT-8-108-18



Olivecrona

MT-8-109-19



Milligan

MT-8-110-21



Davis

MT-8-111-21



Dura Dissector

MT-8-112-22

Neurosurgery



Davis

MT--8-113-24



Love

MT-8-114-19



Olivecrona

MT-8-115-18



Scoville

MT-8-116-23



Holsher

MT-8-117-24



Scoville

MT-8-118-19

Neurosurgery



Groningen

MT-8-119-26



Groningen

MT-8-120-26



Cushing

MT-8-121-19

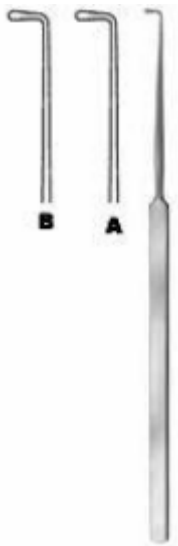

Cushing

MT-8-122-19



Smithwick

MT-8-123-17



Halle

MT-8-125-20

Neurosurgery



Adson

MT-8-126-20



Graham

MT-8-127-16



Sachs

MT-8-128-18



Toennis

MT-8-129-15



Frazier

MT-8-130-13



Krayenbuhl

MT-8-131-01

Neurosurgery



Cloward

MT-8-132-16

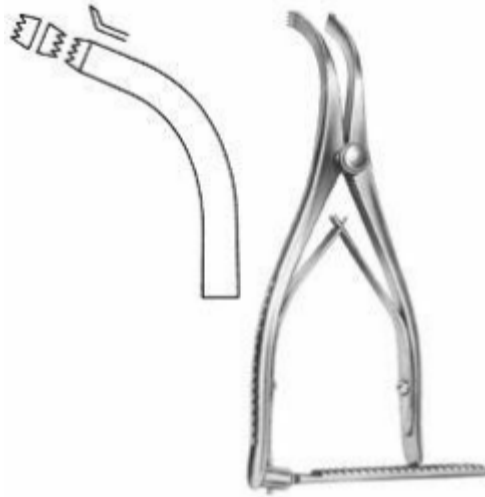

Inge

MT-8-133-17



Inge

MT-8-134-27

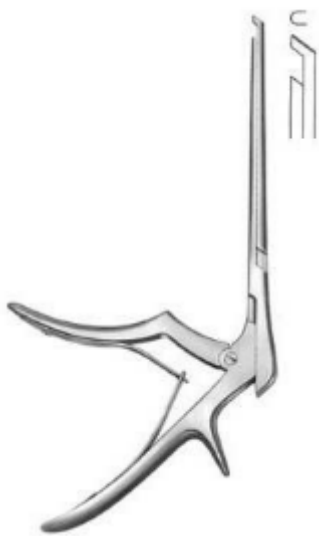

Ferris-Smith Kerrison

MT-8-135-03



Ferris-Smith Kerrison

MT-8-138-01

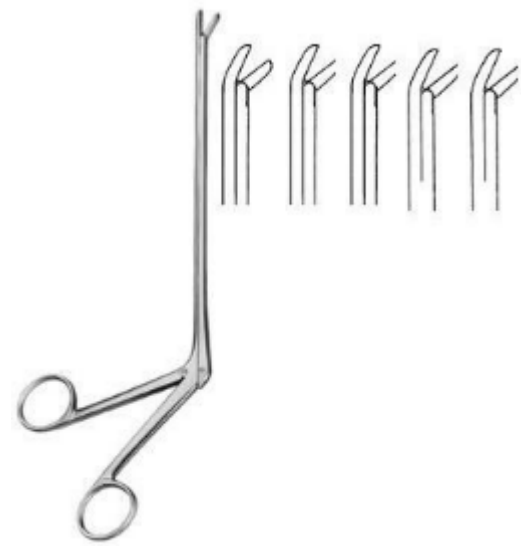

Cushing

MT-8-139-01

Neurosurgery

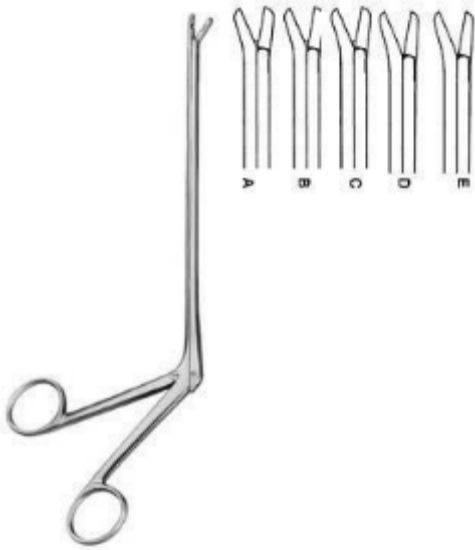

Cushing

MT-8-140-01



Ferris-Smith Kerrison

MT-8-137-01

Cardiovascular



Bone Shear

MT-9-101-23



Rib Shear

MT-9-102-22



Gluck

MT-9-103-22



Giertz-Stille

MT-9-104-27



Lebsche

MT-9-105-24



Rib Retractor

MT-9-106-01

Cardiovascular



Finochietto, Infant

MT-9-107-01



Finochietto, Baby

MT-9-108-01



Finochietto

MT-9-109-01



Burford

MT-9-110-01



Castaneda

MT-9-111-01



Finochietto (modif.)

MT-9-112-01

Cardiovascular



Haight

MT-9-113-90



Morse-Favaloro

MT-9-114-01



Morse

MT-9-115-00



Tuffier

MT-9-116-02

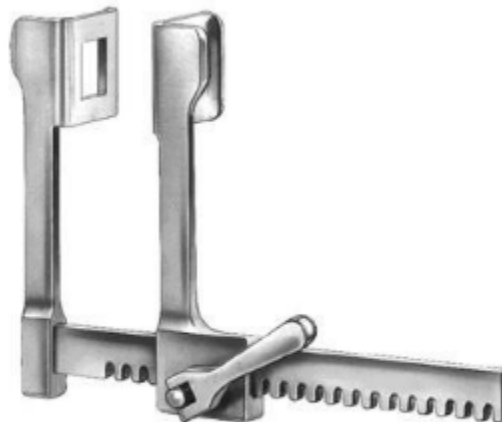

Finochietto, Baby

MT-9-117-75



Finochietto

MT-9-118-01

Cardiovascular



DeBakey

MT-9-119-00



DeBakey

MT-9-120-00



Thoracic Retractor

MT-9-121-00



Sellors

MT-9-121-00



Bailey-Baby

MT-9-123-14



Bailey

MT-9-124-16

Cardiovascular



Bailey-Gibbon

MT-9-125-16



Allison

MT-9-126-30



Price-Thomas

MT-9-127-22



Price-Thomas

MT-9-128-22

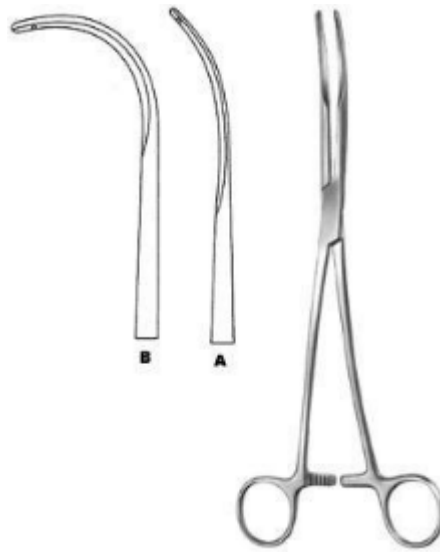

Semb

MT-9-129-24

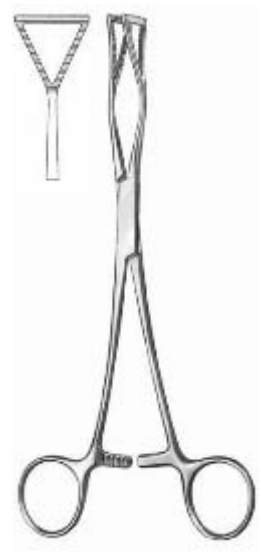

Lovelace

MT-9-130-20

Cardiovascular



Lovelace

MT-9-131-20



DeBakey-Satinsky

MT-9-132-07



Glover

MT-9-133-06



Santulli

MT-9-134-07



Gregory, Soft

MT-9-135-09



Gregory

MT-9-136-01

Cardiovascular

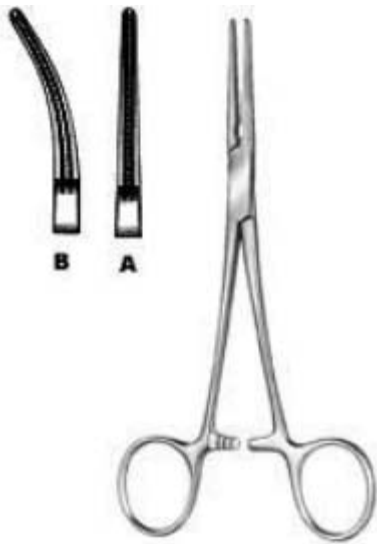

DeBakey-Rankin

MT-9-137-16



DeBakey-Mosquito

MT-9-138-15



Ochsner

MT-9-139-23



Diethrich

MT-9-140-21



Dardik

MT-9-141-00



Dale

MT-9-142-18

Cardiovascular

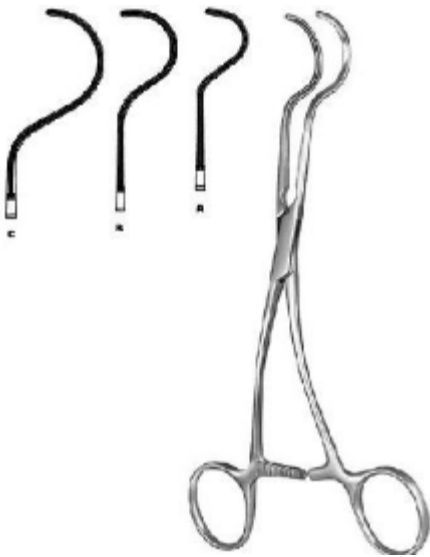

Dale

MT-9-143-17

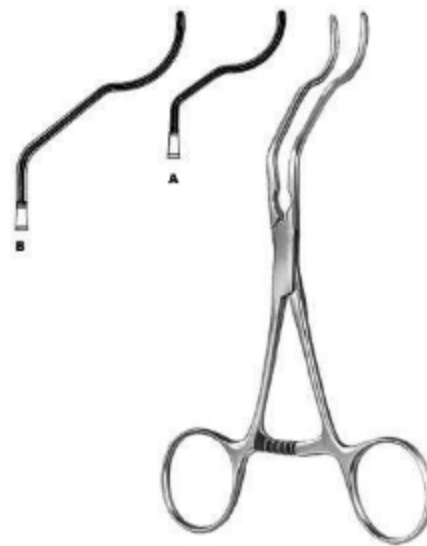

Gregory

MT-9-144-14

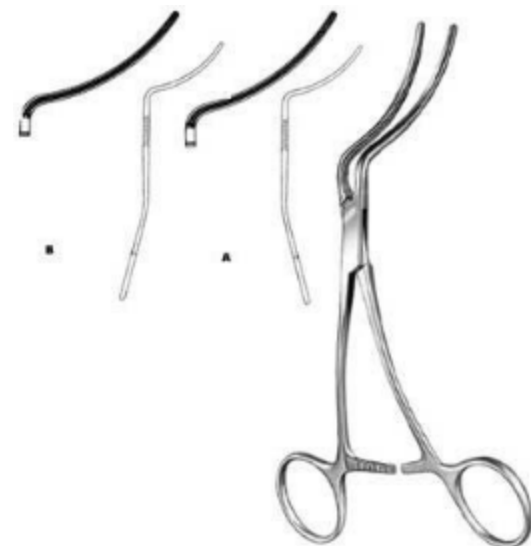

Martin

MT-9-145-16



Husfeldt

MT-9-146-18



Husfeldt

MT-9-147-18



Husfeldt

MT-9-148-17

Cardiovascular



DeBakey

MT-9-149-16



DeBakey

MT-9-150-16



DeBakey

MT-9-151-16



DeBakey

MT-9-152-16



DeBakey

MT-9-153-16



DeBakey

MT-9-154-07

Cardiovascular



DeBakey
MT-9-155-07



Applying Forceps
MT-9-156-23



Glover
MT-9-157-06



Glover
MT-9-158-06



Potts
MT-9-159-21

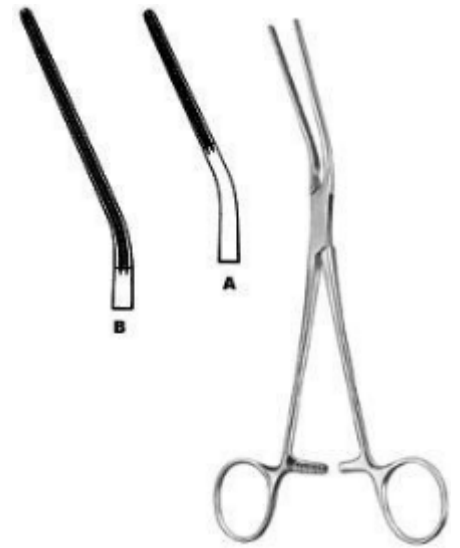

Potts
MT-9-160-21

Cardiovascular

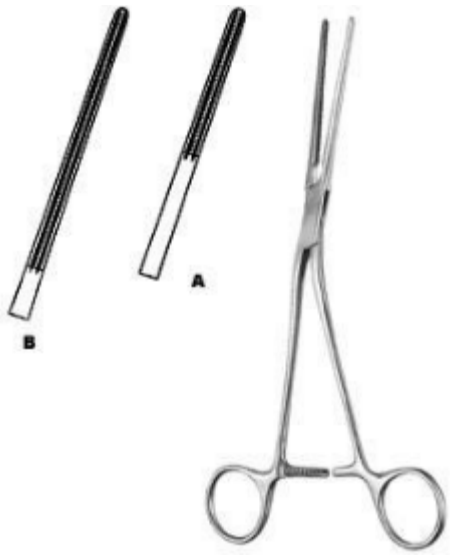

Potts

MT-9-161-21



Potts

MT-9-162-22



Potts

MT-9-163-22



DeBakey

MT-9-164-19



DeBakey

MT-9-165-16



DeBakey

MT-9-166-19

Cardiovascular



Leland-Jones

MT-9-167-18



Bainbridge

MT-9-168-15



Bainbridge

MT-9-169-15

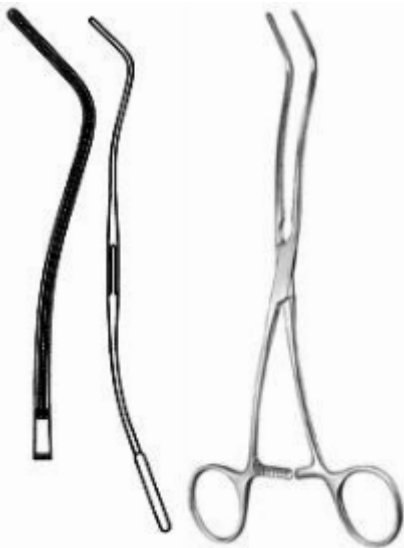

DeBakey

MT-9-170-20



DeBakey

MT-9-171-26

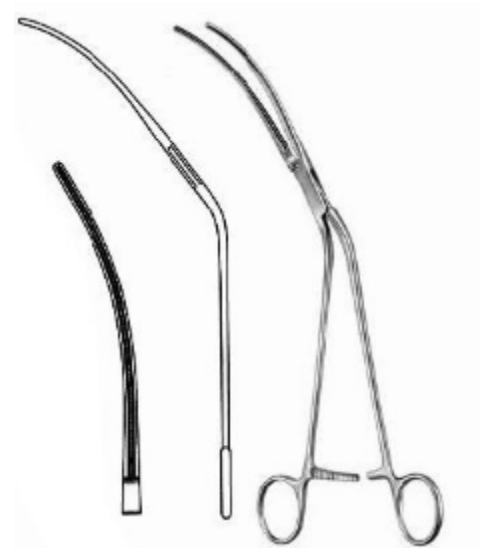

DeBakey

MT-9-172-28

Cardiovascular



DeBakey

MT-9-173-30



DeBakey

MT-9-174-27



DeBakey

MT-9-175-24



DeBakey

MT-9-176-24



DeBakey

MT-9-178-25

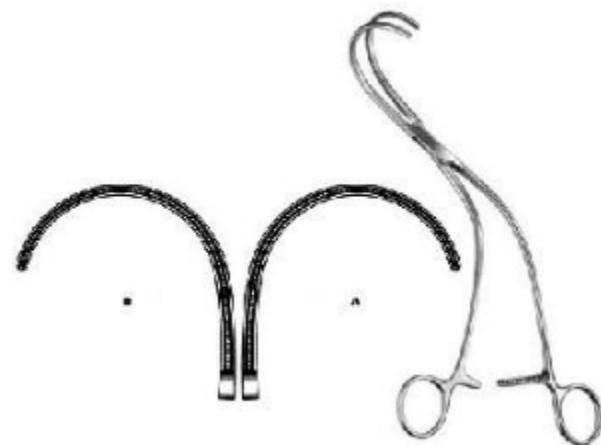

Weber

MT-9-179-01

Cardiovascular



Satinsky

MT-9-180-20



Harken

MT-9-181-01



Lees

MT-9-182-23



Lees

MT-9-183-25



Lambert-Kay

MT-9-184-21



DeBakey

MT-9-185-17

Cardiovascular



Morris-DeBakey

MT-9-186-18



DeBakey-Bahnson

MT-9-187-23

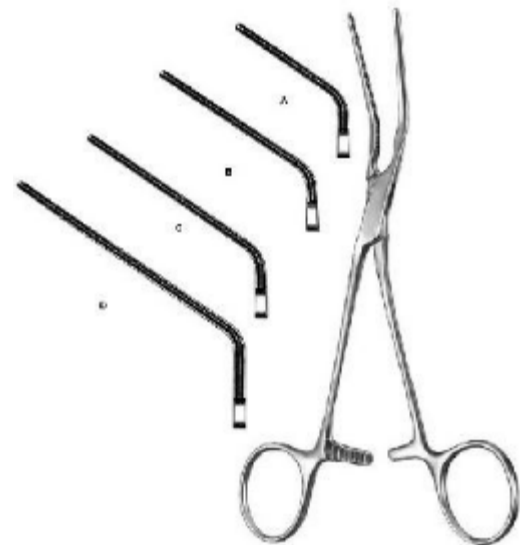

DeBakey

MT-9-188-20

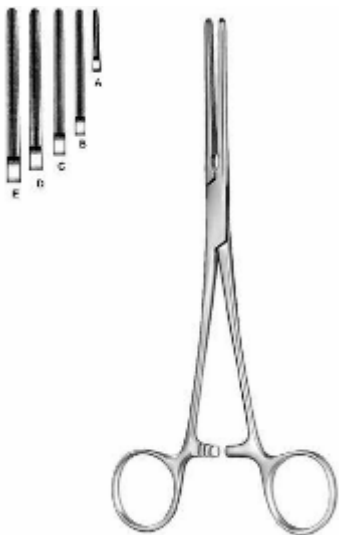

DeBakey-Mosquito

MT-9-189-12



DeBakey-Mosquito

MT-9-190-12



DeBakey

MT-9-191-17

Cardiovascular



DeBakey

MT-9-192-16

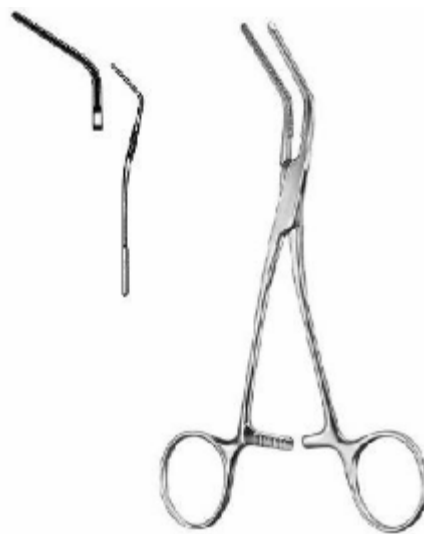

DeBakey

MT-9-193-15



DeBakey

MT-9-194-15

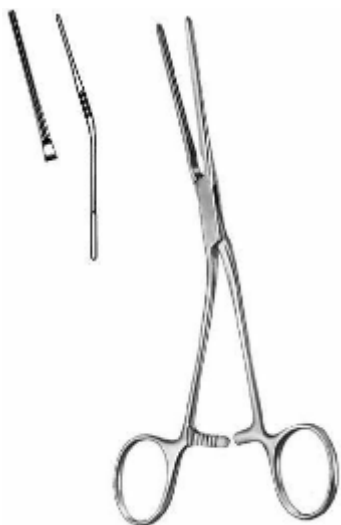

DeBakey

MT-9-195-17



Glover

MT-9-196-17



Glover

MT-9-197-17

Cardiovascular

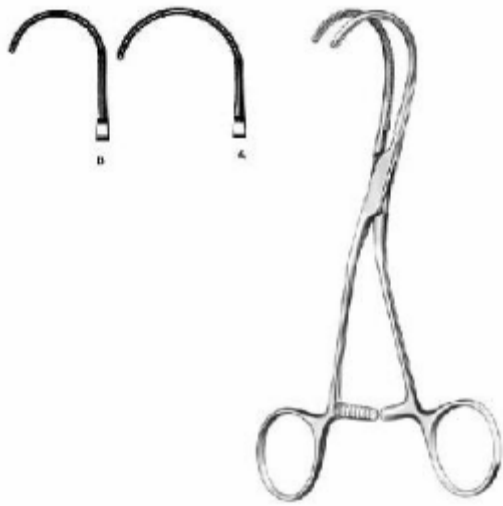

DeBakey

MT-9-198-16

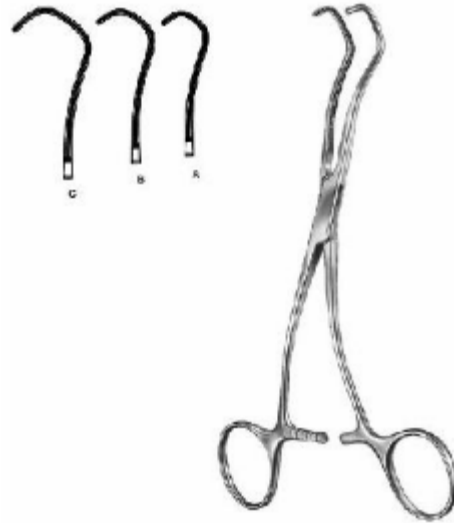

Derra

MT-9-199-16



DeBakey-Beck

MT-9-200-17



Cooley

MT-9-201-16

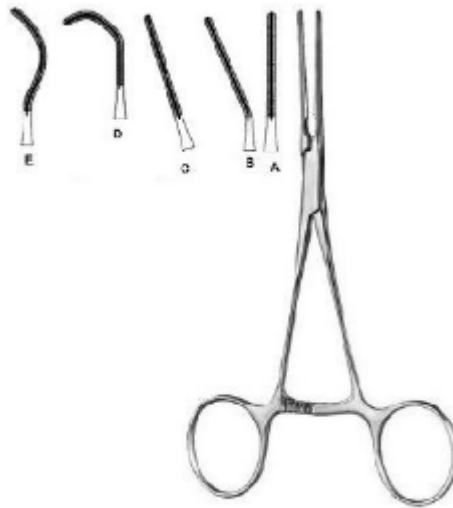

Cooley

MT-9-202-01



Cooley

MT-9-203-21

Cardiovascular



Cooley
MT-9-204-17

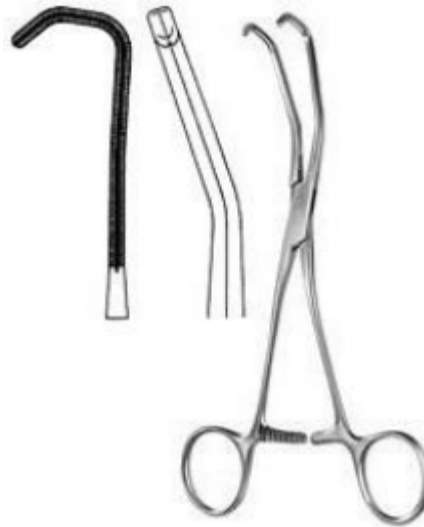

Cooley
MT-9-205-17



Cooley
MT-9-206-16



Cooley
MT-9-207-15



Cooley
MT-9-208-17



Cooley
MT-9-209-17

Cardiovascular



Cooley
MT-9-210-17



Cooley
MT-9-211-16



Cooley-Derra
MT-9-212-16



Cooley-Beck
MT-9-213-17

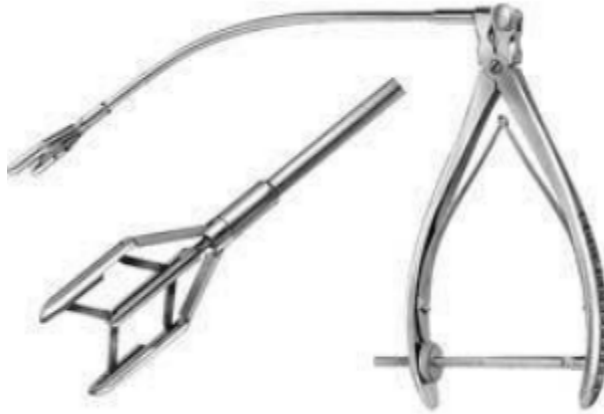

Cooley
MT-9-214-00



Cooley
MT-9-215-05

Cardiovascular



DeBakey

MT-9-216-05



Martin

MT-9-217-00



Hach

MT-9-218-01



Intima Spatula

MT-9-219-18

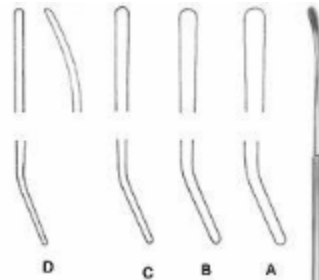

Robb

MT-9-220-01



Crile

MT-9-221-20

Cardiovascular

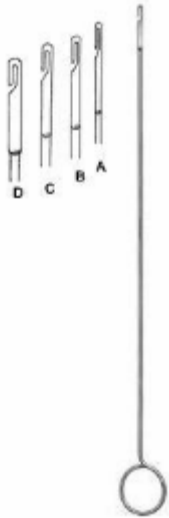

Ligature Catcher

MT-9-222-15



Subramanian-Miniature

MT-9-223-15

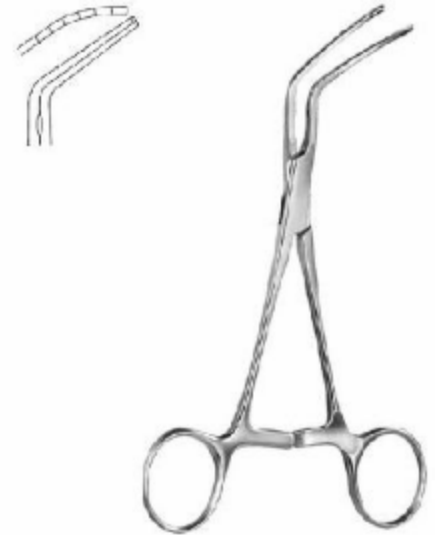

Subramanian

MT-9-224-16

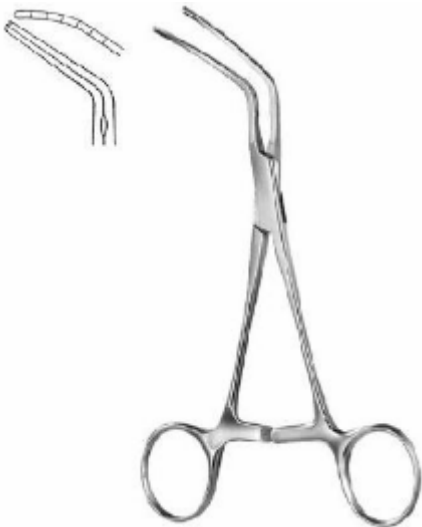

Subramanian

MT-9-225-16

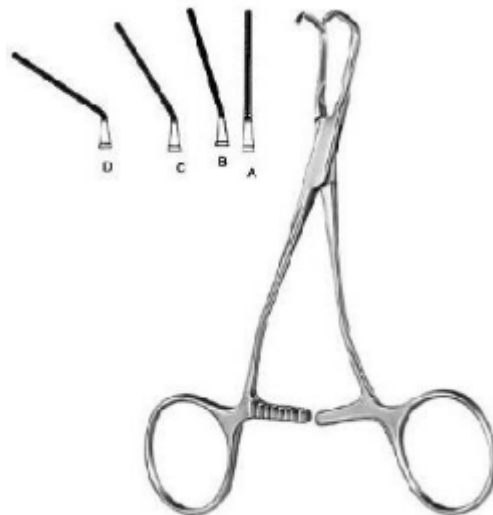

Pediatric Vascular Clamp

MT-9-226-01



Pediatric Vascular Clamp

MT-9-227-16

Cardiovascular



Pediatric Vascular Clamp

MT-9-228-16

Ophthalmology



Barraquer (Colibri)

MT-11-101-03



Bowman

MT-11-102-07



Critchett

MT-11-103-06

Tracheotomy



Ueckermann

MT-16-101-13



Iterson

MT-16-102-16



Rose

MT-16-103-13



Luer

MT-16-104-11



Tracheal Hook

MT-16-105-15



Lukens

MT-16-106-17

Tracheotomy



Jackson
MT-16-107-17



Kocher
MT-16-108-15



Kocher
MT-16-109-15



Hofmeister
MT-16-110-21

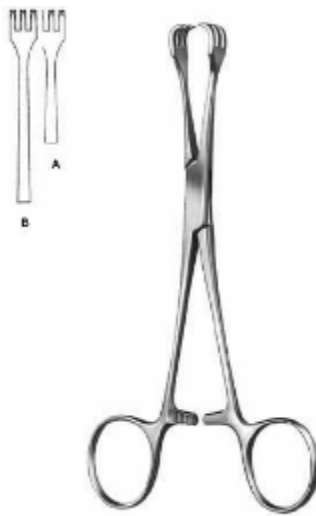

Lahey
MT-16-111-15



Luer
MT-16-112-04

Tracheotomy



Luer

MT-6-113-08



Chevalier-Jackson

MT-16-114-04



Speaking Tube

MT-16-115-08

Dermatology



Moncorps

MT-17-101-14



Moncorps

MT-17-102-00



Vidal

MT-17-103-14



Wolff

MT-17-105-01



Kilner

MT-17-106-15



Gillies

MT-17-107-18

Dermatology



Kaye

MT-17-108-03

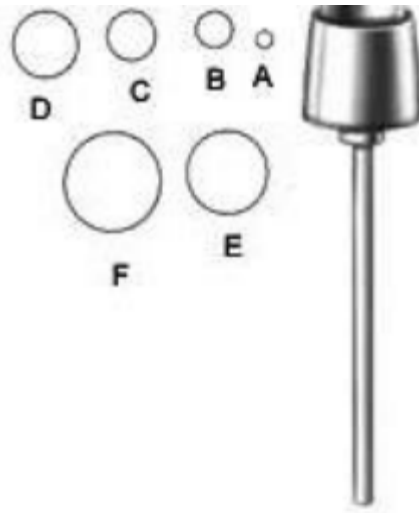

Dermal Punch

MT-17-109-02



Handle

MT-17-110-00

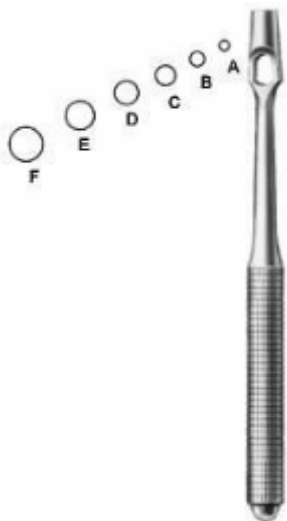

Keys

MT-17-111-02



Unna

MT-17-113-14



Saalfeld

MT-17-114-10

Dermatology



Saalfeld

MT-17-115-14



Schamberg

MT-17-116-10



Katsch

MT-17-117-14

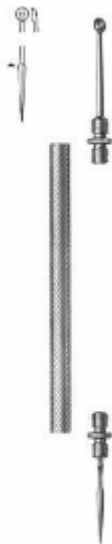

Unna-Vidal

MT-17-118-11



D'Assump?

MT-17-119-15



Gregory

MT-17-120-14

Dermatology

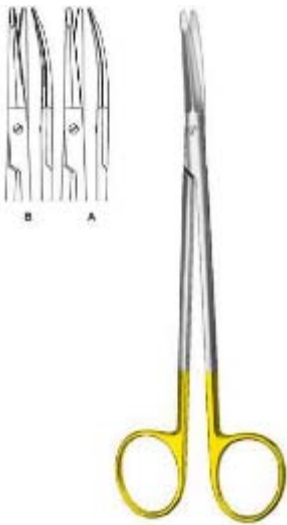

Kaye

MT-17-121-15



Stella-S

MT-17-122-18

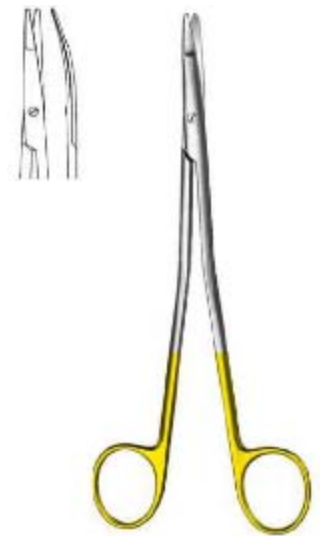

Gorney

MT-17-123-18

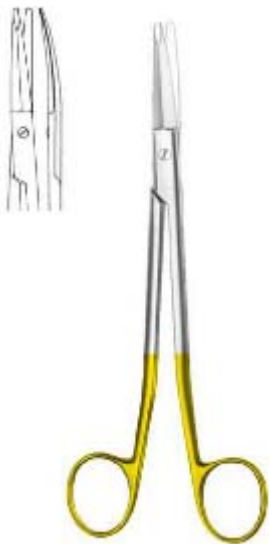

Freeman-Kaye

MT-17-124-18

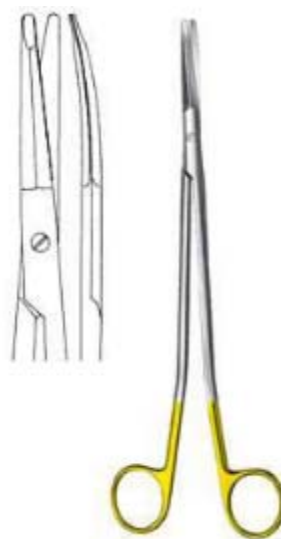

Freeman

MT-17-125-00



Fox

MT-17-104-01

Dermatology



Unna

MT-17-112-14

Intestines & Stomach



Allis-Baby

MT-18-101-12

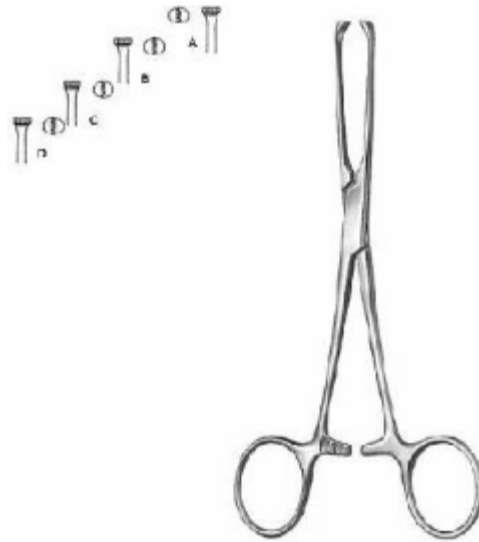

Allis

MT-18-102-15

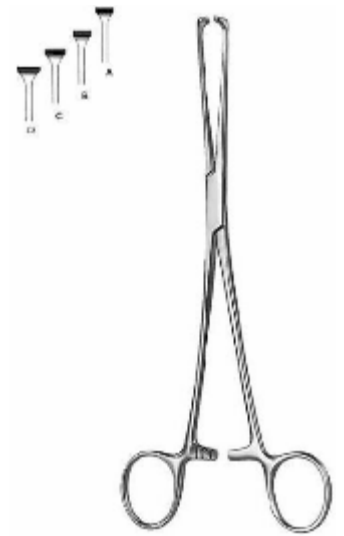

Allis

MT-18-103-16



Allis-Adair

MT-18-104-15



Boys-Allis

MT-18-105-15



Thoms-Allis

MT-18-106-20

Intestines & Stomach



Allis

MT-18-107-20



Lockwood

MT-18-108-20



Williams

MT-18-109-16

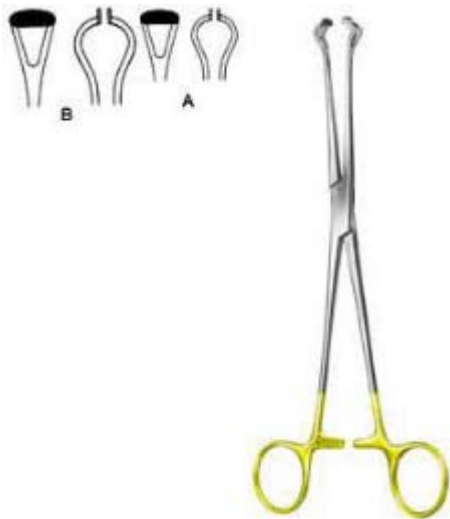

Babcock

MT-18-110-16

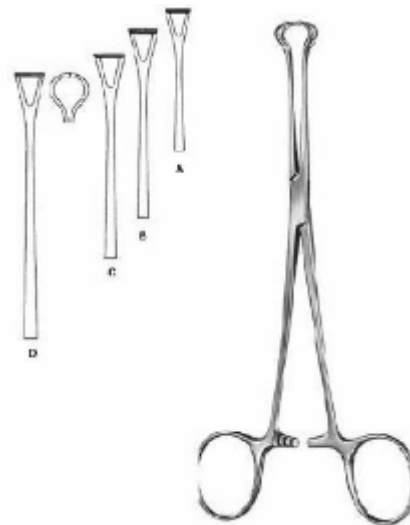

Babcock

MT-18-111-16



Babcock

MT-18-112-16

Intestines & Stomach



Duval

MT-18-113-20

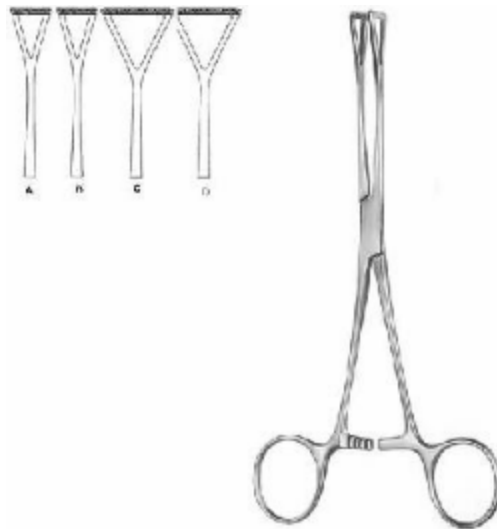

Duval

MT-18-114-18

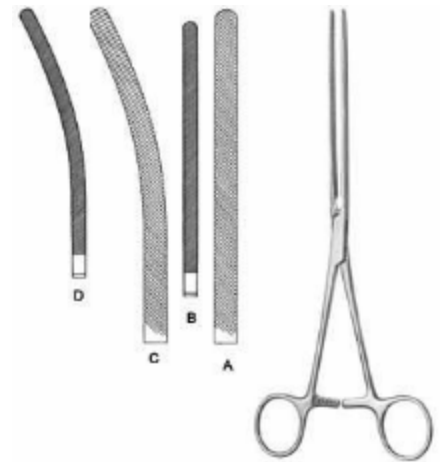

Doyen

MT-18-115-21



Doyen-Baby

MT-18-116-18



Mayo-Robson

MT-18-117-21

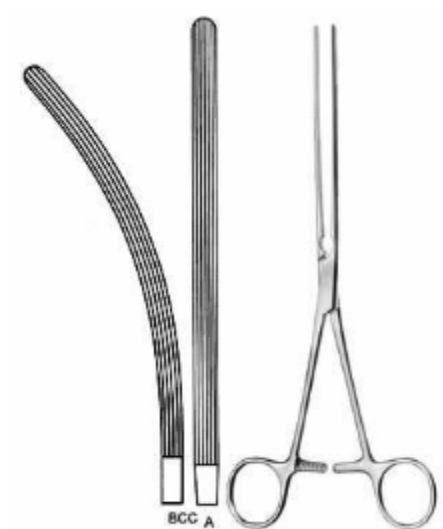

Mayo-Robson

MT-18-118-25

Intestines & Stomach

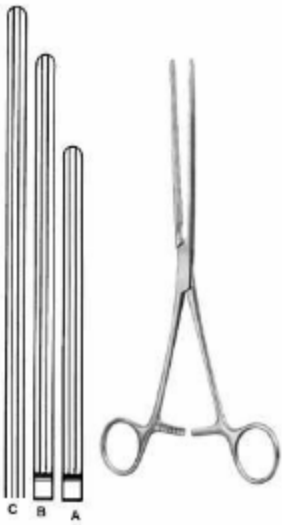

Kocher

MT-18-119-22

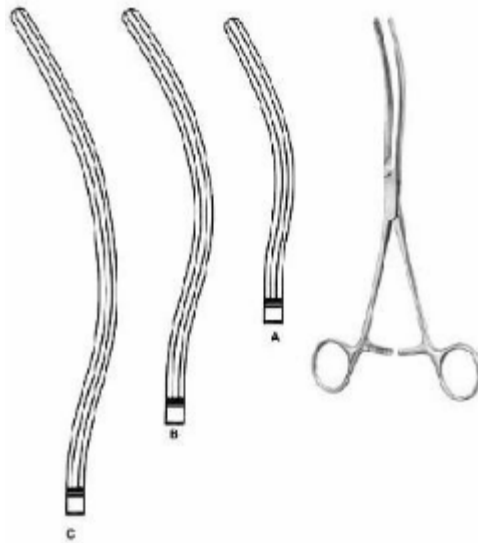

Kocher

MT-18-120-22



Allen

MT-18-121-16



Payr-Baby

MT-18-122-15

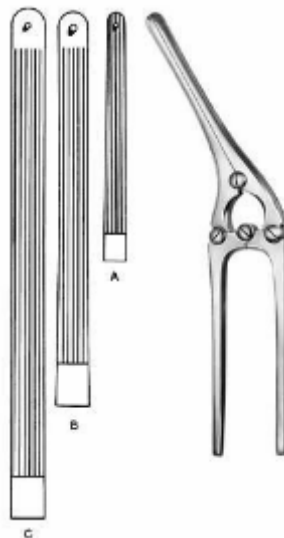

Payr

MT-18-123-21



Stone-Watt

MT-18-124-07

Intestines & Stomach



Stone-Watt

MT-18-125-15

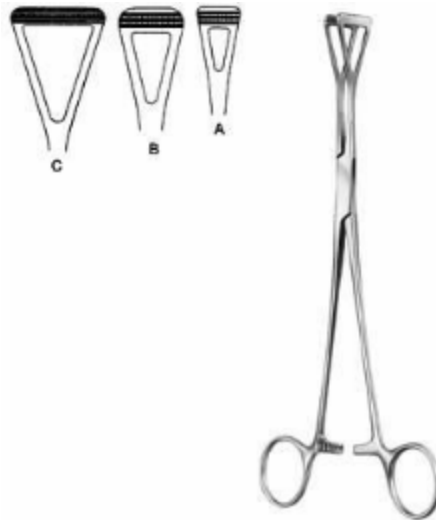

Scheibe

MT-18-126-18



Doyen-Baby

MT-18-127-13

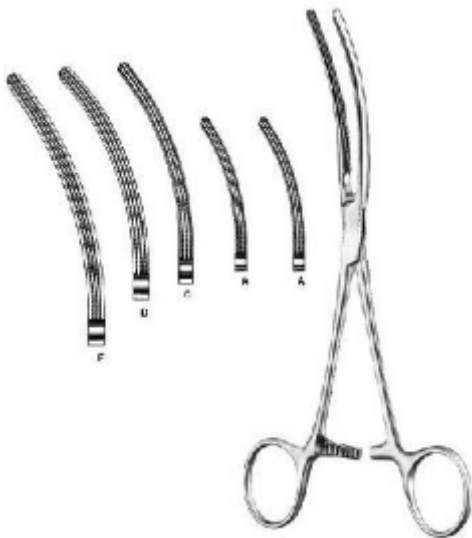

Doyen-Baby

MT-18-128-13



Mayo-Robson

MT-18-129-25



Mayo-Robson

MT-18-130-25

Intestines & Stomach

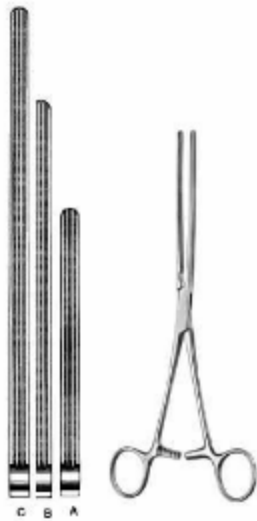

Kocher

MT-18-131-22



Kocher

MT-18-132-22



Scudder

MT-18-133-33

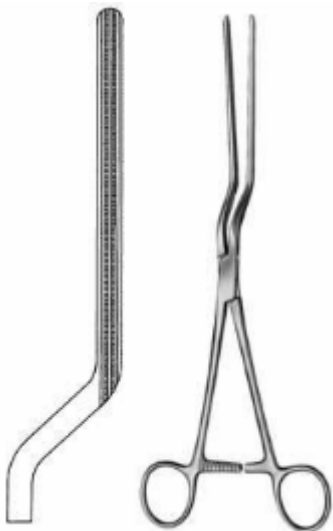

Brunner

MT-18-134-24



Hayes

MT-18-135-26



Veidenheimer

MT-18-136-23

Intestines & Stomach



Fehland

MT-18-137-24



Resano

MT-18-138-30



Sims

MT-18-139-15



Sims

MT-18-140-15



Mathieu

MT-18-141-19



Alan-Parks

MT-18-142-00

Intestines & Stomach



McGinvey

MT-18-143-19



Handle For Biopsy Forceps

MT-18-144-00



Rectal Biopsy Forceps

MT-18-145-38

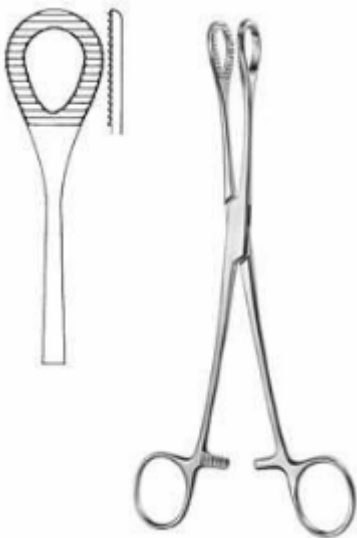

Heywood-Smith

MT-18-146-21

Urology



Randall

MT-19-101-23 A



Randall

MT-19-102-23 A

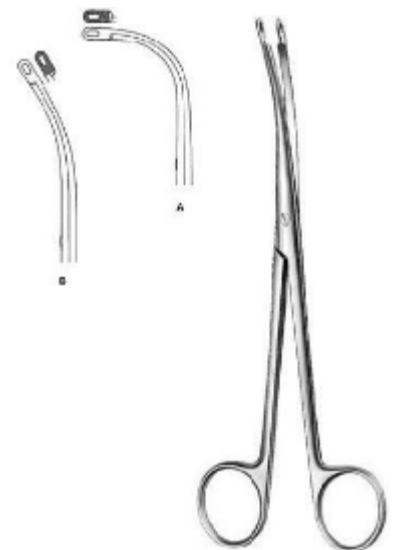

Heiming

MT-19-103-16 A



Elsasser

MT-19-104-01 A



Bakes

MT-19-105-01 A

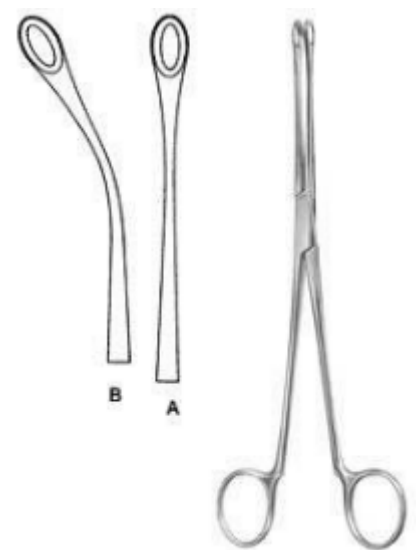

Blake

MT-19-106-20 A

Urology



Mayo-Blake

MT-19-107-20



Mayo-Blake

MT-19-108-20



Mixer

MT-19-109-22



Desjardins

MT-19-110-23 A

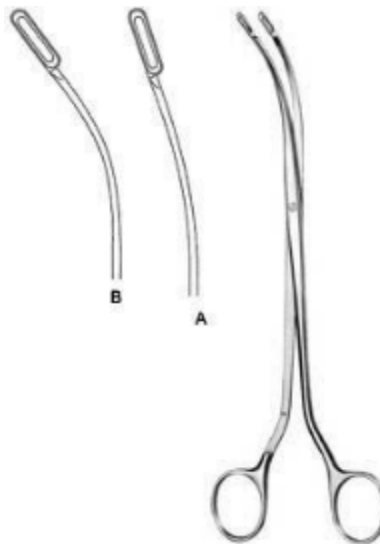

Desjardins

MT-19-111-24 A



Luer-Korte

MT-19-112-01 A

Urology

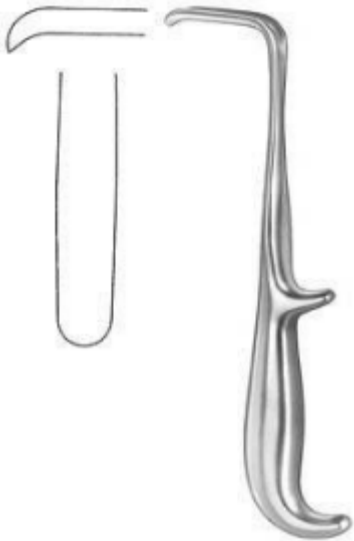

Young
MT-19-113-21



Young
MT-19-114-22



Young
MT-19-115-21

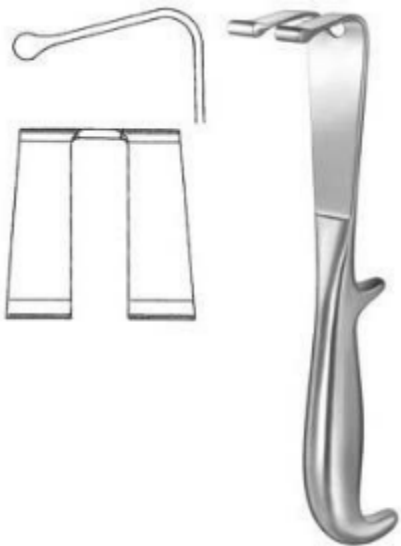

Young
MT-19-116-22



Millin
MT-19-117-24

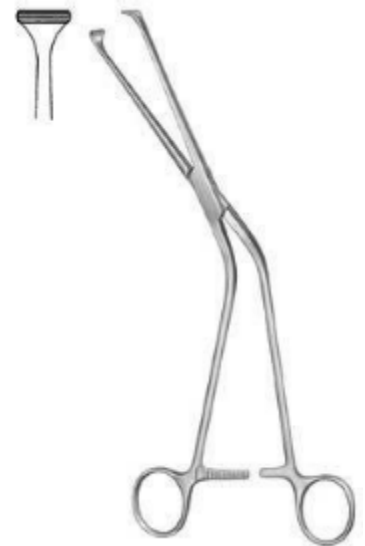

Millin
MT-19-118-24

Urology

Image



Millin

MT-19-119-23



Millin

MT-19-120-23

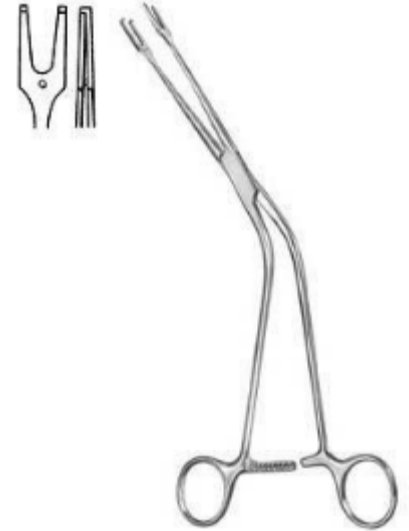

Millin

MT-19-121-24



Millin

MT-19-122-00



Thomson-Walker

MT-19-123-00



Judd-Masson

MT-19-124-00

Urology



Millin

MT-19-125-00 A



Legueu

MT-19-126-27

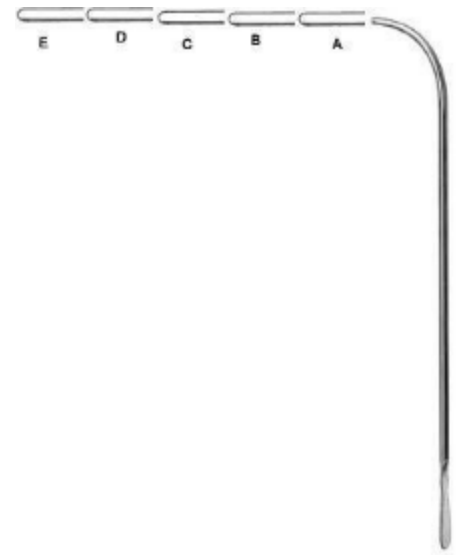

Van Buren

MT-19-127-00 A

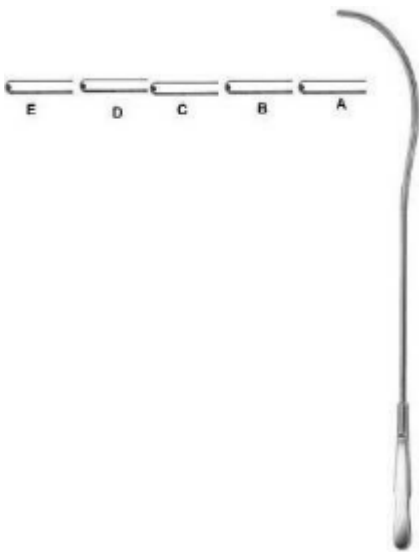

Guyon

MT-19-128-10 A

Gynecology



Cusco
MT-20-101



Cusco
MT-20-102-01



Cusco
MT-20-103-01



Cusco
MT-20-104-01



Collin
MT-20-105-01



Pederson
MT-20-106-01

Gynecology



Grave

MT-20-107-01



Semm

MT-20-108-01



Sims

MT-20-109-01



Kristeller

MT-20-110-01



Kristeller

MT-20-111-01



Kristeller

MT-20-112-01

Gynecology



Kristeller
MT-20-113-01



Kristeller
MT-20-114-01



Kristeller
MT-20-115-01

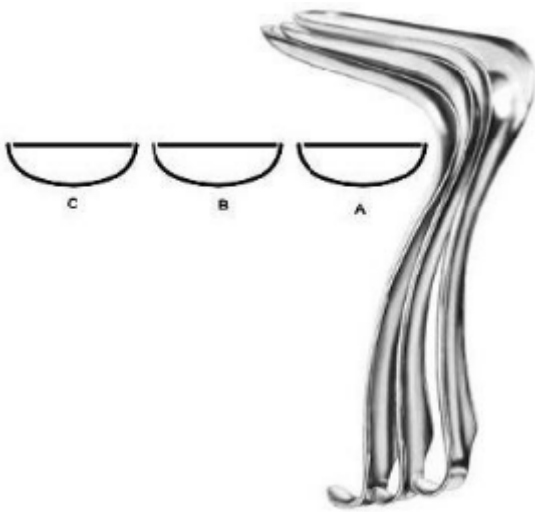

Kristeller
MT-20-116-01

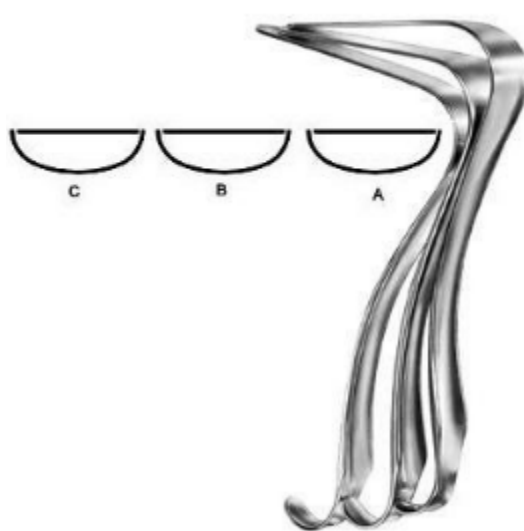

Kristeller
MT-20-117-01



Kristeller
MT-20-118-01

Gynecology

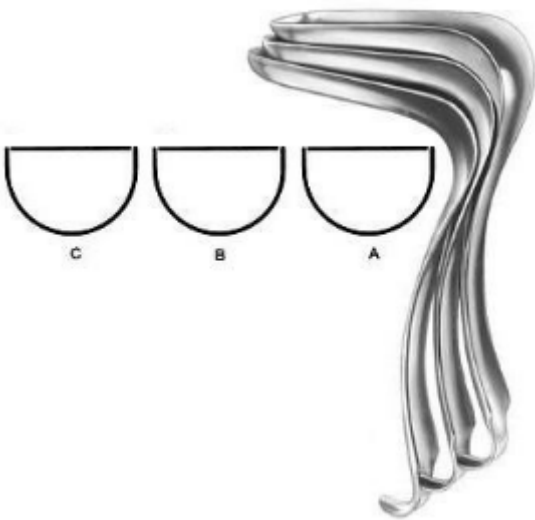

Kristeller
MT-20-119-01

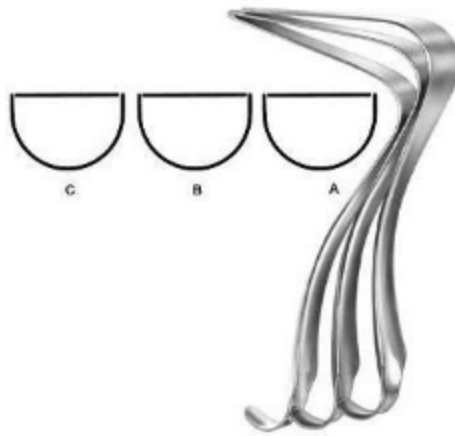

Kristeller
MT-20-120-01

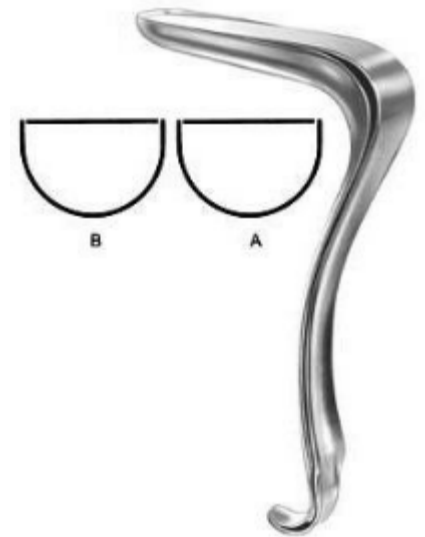

Kallmorgen
MT-20-121-01



Kallmorgen
MT-20-122-01



Kallmorgen
MT-20-123-01

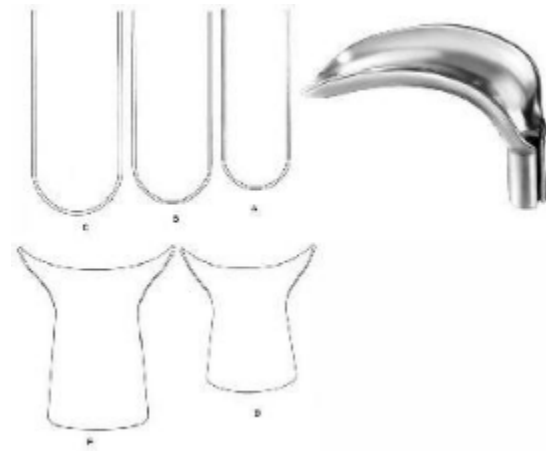

Scherbak
MT-20-125-00

Gynecology



Auvard

MT-20-126-22



Weissbarth

MT-20-127-24



Breisky

MT-20-128-20



Kogan

MT-20-129-24



Kogan

MT-20-130-24



Hegar

MT-20-131-24

Gynecology



Hegar

MT-20-132-02



Hank

MT-20-133-10



Sims

MT-20-134-32



Valleix

MT-20-135-25



Braun

MT-20-136-26



Schroder

MT-20-137-25

Gynecology



Braun

MT-20-138-25



Duplay

MT-20-139-28



Beacham

MT-20-140-26



Skene

MT-20-141-24

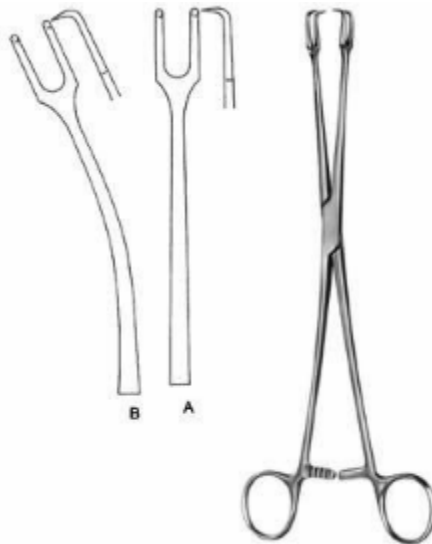

Schroder

MT-20-142-24



Teale

MT-20-143-23

Gynecology



Iowa

MT-20-144-26



Museux

MT-20-145-24



Jacobs

MT-20-146-21

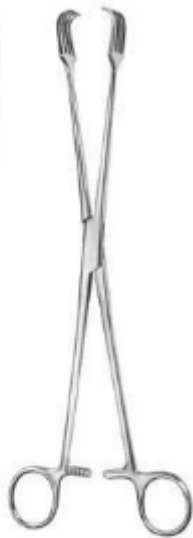

Uterine Tenaculum Forcep

MT-20-147-26



Braun

MT-20-148-16

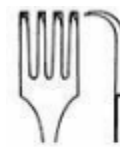

Czerny

MT-20-149-21

Gynecology

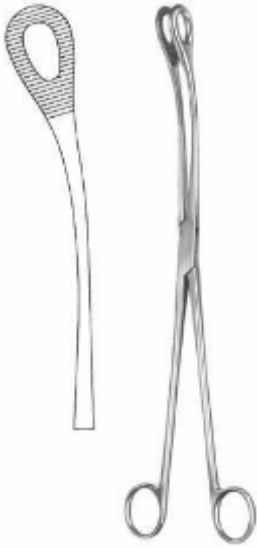

Kelly

MT-20-150-32



Noto

MT-20-151-27

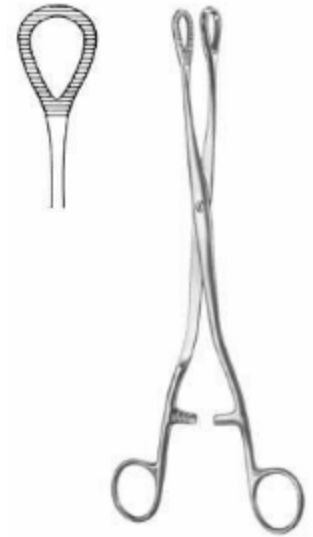

Heywood-Smith

MT-20-152-25



Doyen

MT-20-153-17



Doyen

MT-20-154-17



Segond

MT-20-155-27

Gynecology



Dartigues

MT-20-156-27



Somer

MT-20-157-27



Collin

MT-20-158-25



Ayre

MT-20-159-23



Emmett

MT-20-160-03



Simon

MT-20-161-22

Gynecology



Simon

MT-20-162-22



Novak

MT-20-163-23



Kevorkian

MT-20-164-23



Munchen

MT-20-165-27



Gellhorn

MT-20-166-23



Faure

MT-20-167-21

Gynecology



Schubert

MT-20-168-21



Thoms-Gaylor

MT-20-169-22



Schubert

MT-20-170-26

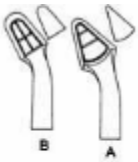

Van Doren

MT-20-171-24



Alexander

MT-20-172-28



Kevorkian

MT-20-173-32

Gynecology

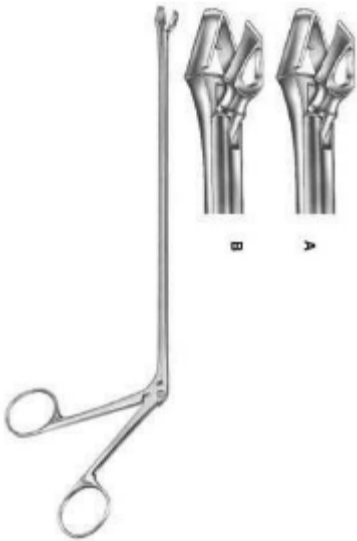

Schumacher

MT-20-174-01



Schumacher

MT-20-175-00



IUP Grasping Forceps 3 Mm ?

MT-20-176-22

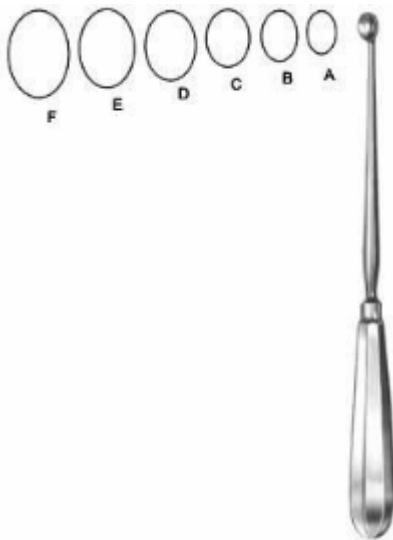

Simon

MT-20-177-01



Simon

MT-20-178-01



Recamier

MT-20-179-05

Gynecology



Recamier

MT-20-180-05



Sims

MT-20-181-05



Sims

MT-20-182-05



Suction Curette

MT-0-183-03

Obstetrics



Martin

MT-21-101-34



Nagele

MT-5-102-36



Simpson

MT-5-103-30



Wrigley

MT-5-104-28



Simpson

MT-21-105-36



Kielland

MT-21-106-41

Obstetrics

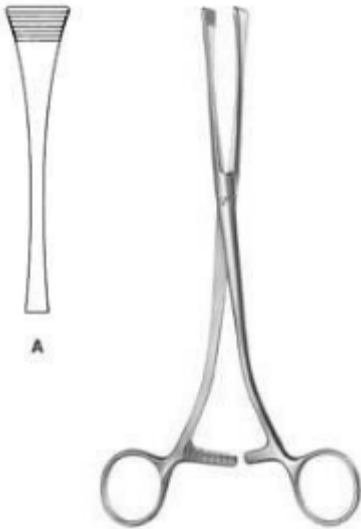

Green-Armytage

MT-21-107-21



Sellheim

MT-21-108-28

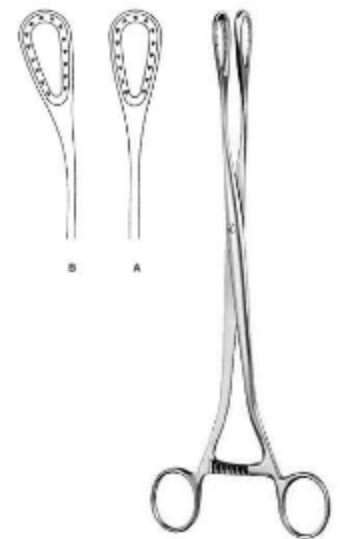

Sanger

MT-21-109-27

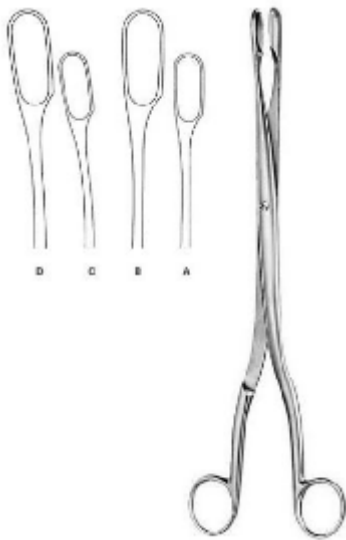

Winter

MT-21-110-01

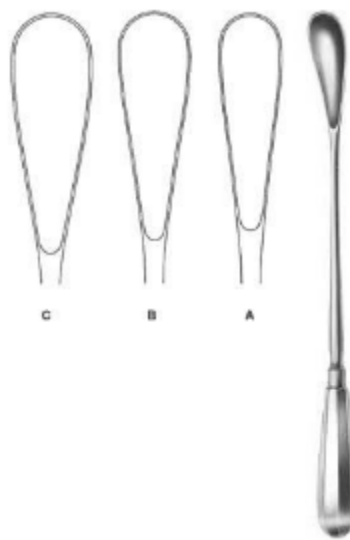

Cuzzi

MT-21-111-01



Pestalozza

MT-21-112-30

Obstetrics



Kane

MT-21-113-08



Collin

MT-21-114-09

Sterilization



Irrigator

MT-23-101-10



Round Bowl

MT-23-102-16



Round Bowl

MT-23-103-33



Flat Dish

MT-23-104-11



Lid Only

MT-23-105-11



Stainless Steel

MT-23-106-04

Sterilization



Round Dish

MT-23-107-11



Flat Dish

MT-23-108-11



Measurer

MT-23-109-01



Measurer

MT-23-110-02



Petri Dish

MT-23-111-10



Petri Dish

MT-23-112-09

Sterilization



Lid For Petri Dishes

MT-23-113-10



Universal Tray

MT-23-114-23



Instrument Tray

MT-23-115-21



Universal Tray

MT-23-116-23



Round Bowl

MT-23-117-22



Metal Jar

MT-23-118-30

Sterilization



Instrument Box

MT-23-119-16



Instrument Box

MT-23-120-16



Instrument Box

MT-23-121-20



Round Metal Box

MT-23-122-06



Medicine Cup Graduated Inside

MT-23-123-25



Medicine Cup Graduated Inside

MT-23-124-50

Sterilization



Tablet Tray

MT-23-125-75



Metal Cup

MT-23-126-90



Denture Cup

MT-23-127-75



Insert For Cup

MT-23-128-75



Kidney Dish

MT-23-129-17



Placenta Pan

MT-23-130-36

Sterilization



Waste Cotton Collector

MT-23-131-01



Spirit Lamp

MT-23-132-07

Bone Surgery



Charrière
MT-7-102-35



Langenbeck
MT-7-103-23



Charrière
MT-7-104-27



Reamer
MT-7-105-14



Perthes
MT-7-106-18



Perthes
MT-7-107-21

Bone Surgery



Reamer

MT-7-108-14



Flat Trephine

MT-7-111-18



Wire Twisting Forceps

MT-7-112-01



Wire Twisting Forceps

MT-7-113-15



Flat Nose Plier

MT-7-114-17



Wire Twisting Forceps

MT-7-115-18

Bone Surgery



Combi-Flat Nose Plier

MT-7-116-15



Flat Nose Plier

MT-7-117-01

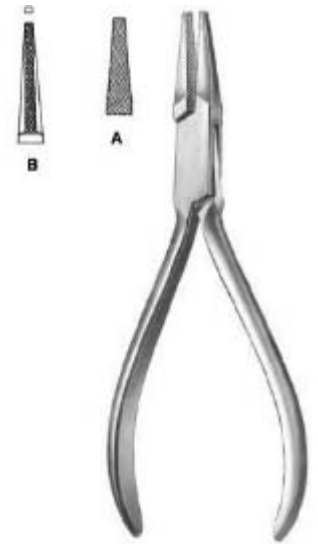

Flat Nose Plier

MT-7-118-14



Hackstock

MT-7-119-16



Flat Nose Plier

MT-7-120-01



Wire Cutting Pliers

MT-7-121-18

Bone Surgery



Wire Cutting Pliers

MT-7-122-15



Wire Cutting Pliers

MT-7-123-18



Demel

MT-7-124-18

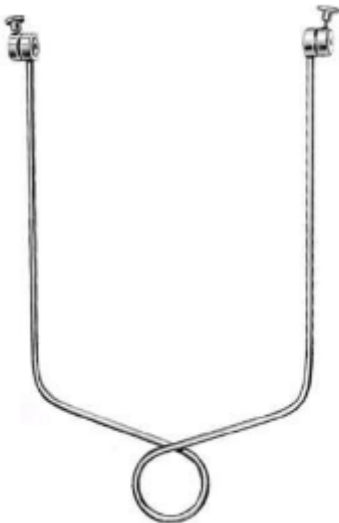

Bohler

MT-7-125-15



Kirschner

MT-7-126-01



**Traction Hook For Extention
Bows**

MT-7-127-06

Bone Surgery



Kirschner
MT-7-128-06



Kirschner
MT-7-129-06



Kirschner
MT-7-130-10



Kirschner
MT-7-131-10



Kirschner
MT-7-132-10



Buckley
MT-7-133-02

Bone Surgery



Buckley

MT-7-134-02



Stout

MT-7-135-03



Bone Chisel

MT-7-112-01



Bone Chisel

MT-7-137-04



Bone Chisel

MT-138-04



Bone Chisel

MT-7-139-04

Bone Surgery

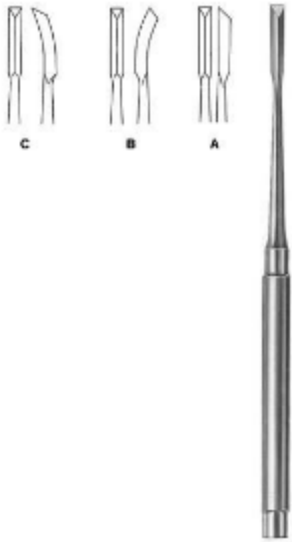

Gardner
MT-7-112-01



Snyder-O.S.U.
MT-7-141-03



O.S.U.
MT-7-142-01



O.S.U.
MT-7-143-01



Osteotome
MT-7-144-08



Chisel
MT-7-145-08

Bone Surgery



Gouge

MT-7-146-08



Partsch

MT-7-147-02



Partsch

MT-7-148-02



Stille

MT--7-149-10



Stille

MT--7-150-10



Stille

MT-7-151-10

Bone Surgery



Lambotte, Mini

MT-7-152-02



Lambotte

MT-7-153-15



Lambotte

MT-7-154-15



Smith-Petersen

MT-7-155-06



Smith-Petersen

MT-7-156-06



Smith-Petersen

MT-7-157-09

Bone Surgery



Smith-Petersen

MT-7-158-09



Hoke

MT-7-159-03

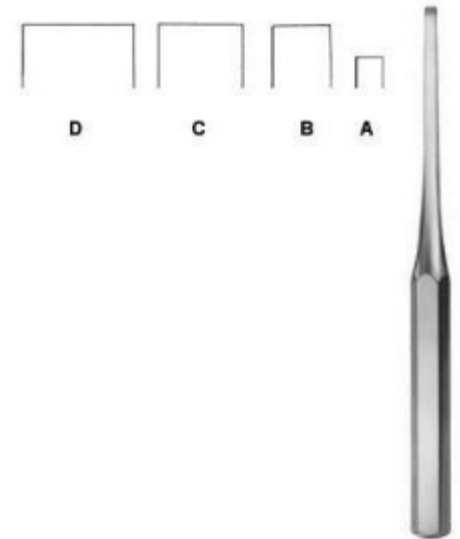

Hibbs

MT-7-151-10

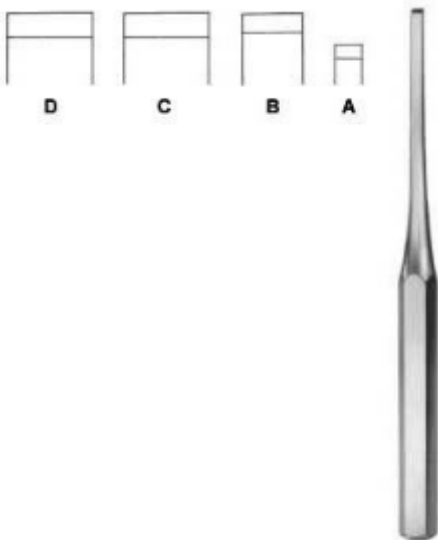

Hibbs

MT-7-161-06

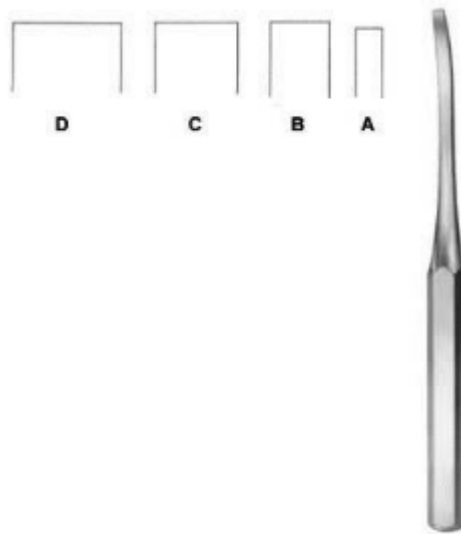

Hibbs

MT-7-162-06

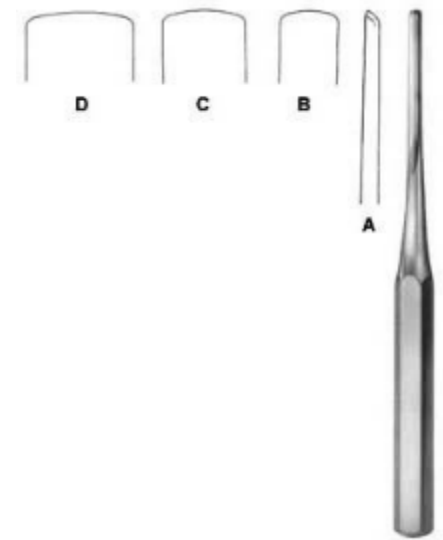

Hibbs

MT-7-163-06

Bone Surgery



Hibbs

MT-7-164-06

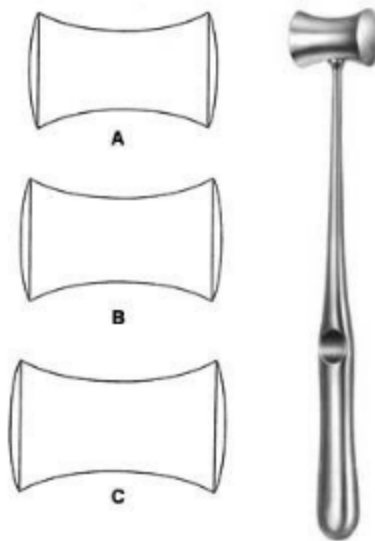

Williger

MT-7-165-01

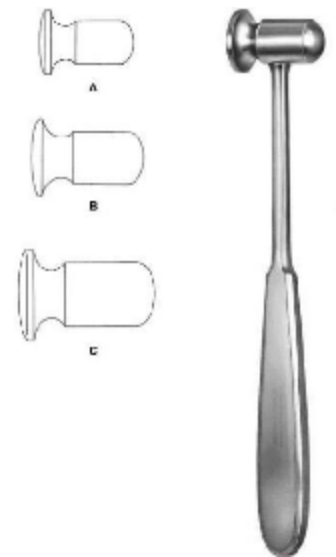

Doyen

MT-7-166-01



Collin

MT-7-151-10

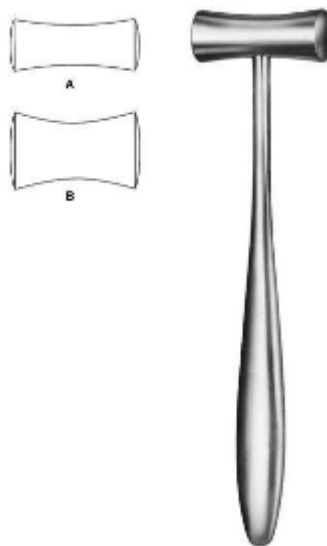

Lucae

MT-7-168-01



Cottle

MT-7-169-19

Bone Surgery



Williger

MT-7-170-01



Mead

MT-7-171-17



Parsch

MT-7-172-18



Schede

MT-7-173-01



Kahre-Williger

MT-7-201-04



Periosteal Elevator

MT-7-202-06

Bone Surgery



Volkmann
MT-7-174-01



Doyen
MT-7-203-17

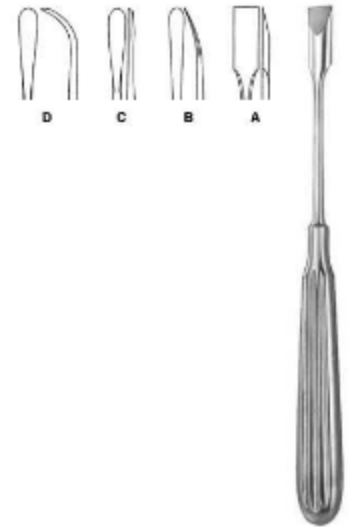

West
MT-7-204-19



Bruns
MT-7-175-01

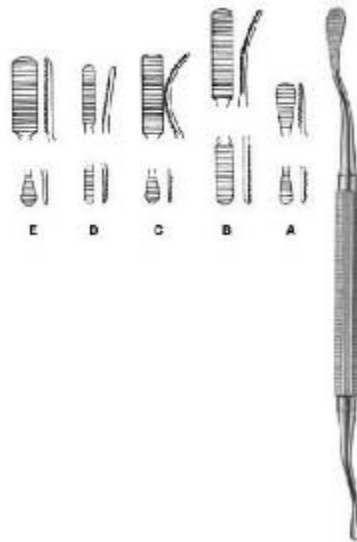

Miller-Colburn
MT-7-209-01



Spratt
MT-7-175-01

Bone Surgery

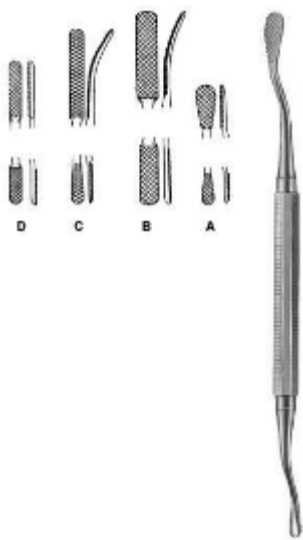

Miller-Colburn

MT-7-210-01



Langenbeck

MT-7-211-20



Bruns

MT-7-177-01



Martin-Langenbeck

MT-7-212-01



Scoville

MT-7-178-25



Vickers

MT-7-213-17

Bone Surgery



Vickers

MT-7-214-17

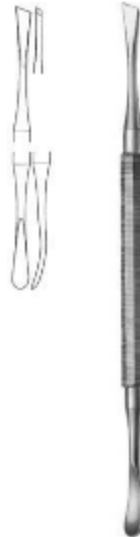

Simon

MT-7-179-01



Williger

MT-7-215-17



Modell USA

MT-7-180-01



Williger

MT-7-216-16



Mead

MT-7-217-17

Bone Surgery



Periosteal Elevator

MT-7-218-18



Hohmann

MT-7-219-43



Modell USA

MT-7-181-01



Lempert

MT-7-220-19



Modell USA

MT-7-182-01



Luer

MT-7-221-17

Bone Surgery



Zaufal-Jansen

MT-7-222-18



Halle

MT-7-183-01



Demel

MT-7-124-01



Volkmann

MT-7-184-01



Volkmann

MT-7-185-13



Bone Curette

MT-7-186-21

Bone Surgery



Williger

MT-7-187-00



Hemingway

MT-7-189-11



Hemingway

MT-7-190-00



Bone Curette

MT-7-191-01

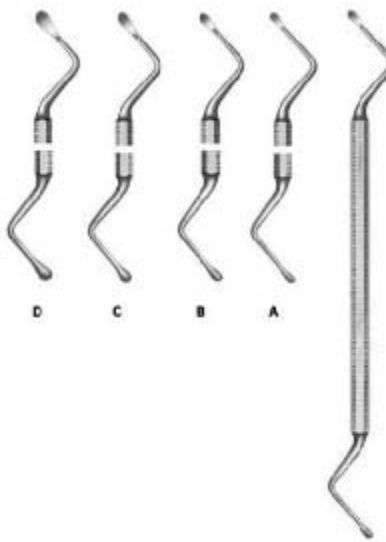

Lucas

MT-7-192-11

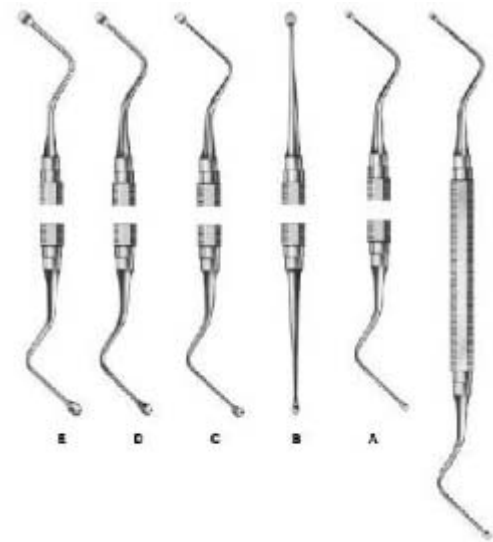

Miller-Colburn

MT-7-193-00

Bone Surgery

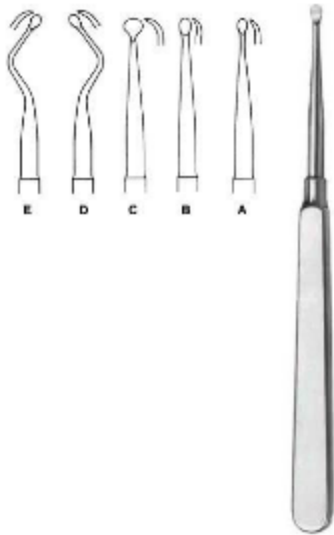

Molt

MT-7-194-01

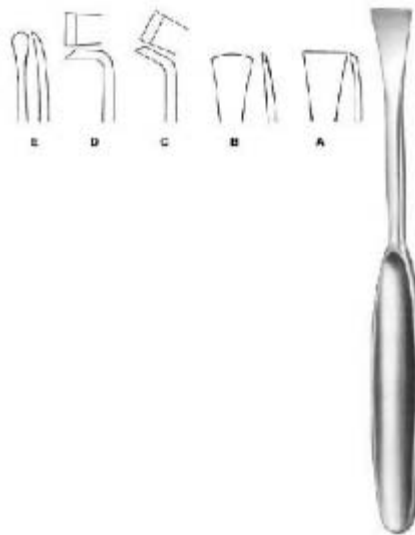

Martin-Langenbeck

MT-7-195-01



Langenbeck

MT-7-196-18



Langenbeck

MT-7-197-19



Periosteal Elevator

MT-7-198-05



Sedillot

MT-7-199-21

Bone Surgery



Williger

MT-7-200-13



Kahre-Williger

MT-7-201-04

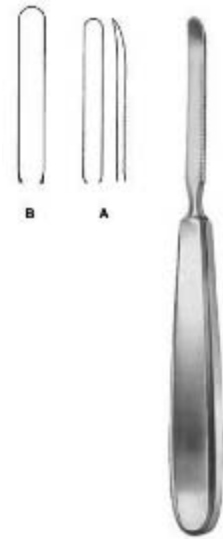

Periosteal Elevator

MT-7-202-06



Doyen

MT-7-203-17

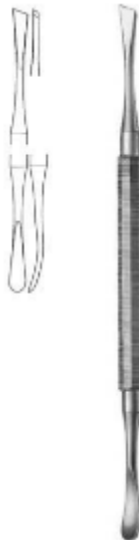

West

MT-7-204-19